



REPORT

PACALTS DORP WEST BULK WATER SUPPLY NEW 14.5 M³ CAPACITY RESERVOIR

Preliminary Design Report

Client: George Municipality

Reference: MD3229-RHD-ZZ-XX-RP-Z-0003

Status: S4/P01

Date: 31 May 2023

ROYAL HASKONINGDHV (PTY) LTD

PO Box 434
George
George
6529
South Africa
Southern Africa
Reg No. 1966/001916/07

+27 87 352 1500 **T**
email **E**
royalhaskoningdhv.com **W**

Document title: PACALTSDORP WEST BULK WATER SUPPLY
NEW 14.5 Ml CAPACITY RESERVOIR
Subtitle: Preliminary Design Report
Reference: MD3229-RHD-ZZ-XX-RP-Z-0003
Status: S4
Date: 31 May 2023
Project name: 14.5 MI Pacaltsdorp
Project number: MD3229
Author(s): Alphonse Mujinga, Keith Turner

Drafted by: Alphonse Mujinga, Keith Turner

Checked by: Japie van Eeden

Date: 31 May 2023

Approved by: Mari Kirsten

Date: 31 May 2023

Classification

Project related

Unless otherwise agreed with the Client, no part of this document may be reproduced or made public or used for any purpose other than that for which the document was produced. Royal HaskoningDHV (Pty) Ltd accepts no responsibility or liability whatsoever for this document other than towards the Client.

Please note: this document contains personal data of employees of Royal HaskoningDHV (Pty) Ltd. Before publication or any other way of disclosing, this report needs to be anonymized, unless anonymisation of this document is prohibited by legislation.

Table of Contents

1	Introduction	8
1.1	Background	8
1.2	Study area	8
1.3	Project objective and scope of work	11
1.4	Project demographic profile	11
2	Purpose of this report	12
3	Guidelines for design analysis	12
3.1	Flows and storage	13
3.2	Pipelines and pipework	13
3.3	Water quality and water age	14
4	Water demand	16
5	Existing Infrastructure	20
5.1	Bulk water supply system	20
5.2	Reservoir PWR-01	21
5.3	Water Tower PWT-01	22
5.4	Pump Station PWT-PS-01	23
6	Scheme development	25
6.1	Scheme phases and modelled scenarios	25
6.2	Schematic layout	29
6.3	Hydraulic model	31
6.4	Recommendation for Preliminary Design	44
7	Option analysis for reservoir shape and top water level	45
7.1	Shape of ground-based reservoir	45
7.2	Top water level co-ordination	48
7.3	Conclusions	50
8	Preliminary design details for proposed infrastructure	51
8.1	Overview	51
8.2	Design criteria	53
8.3	Reservoir PWR-02	56
8.4	Pump station PWT-PS-02	67
8.5	Inter-connecting pipework	73
8.6	Electrical, control and instrumentation requirements	78

8.7	Site works	80
9	Sub consultancy services and Statutory and Legislative requirements	86
9.1	Geotechnical investigation	86
9.2	Topographical surveys	86
9.3	Environmental	86
9.4	Health and Safety	87
9.5	Town planning	87
10	Programme	89
11	Project cost estimate	90
12	Conclusion	92
13	References	92

Table of Tables

Table 1 Project Location	11
Table 2: Population Count	12
Table 3 : Design criteria – flows and storage	13
Table 4: Pipelines and pipework design guidelines	13
Table 5 : Water Quality design criteria	15
Table 6: Demand Horizon and Reservoir Capacity	16
Table 7: Reservoir Storage Capacity	18
Table 8: Pumping Equipment Details	23
Table 9 Scheme phases and modelled scenarios	25
Table 10 : Phases and scenarios – water demands and storage requirements over time	26
Table 11: Results summary Scenario 0	33
Table 12: Results summary Scenario 1	37
Table 13: Results summary Scenario 2	40
Table 14: Reservoir size parameters for 14,5 Ml storage capacity	47
Table 15: Comparison of reservoir levels, water depth and TWL	49
Table 16: Design criteria for Phase 1A infrastructure	53
Table 17: Summary of valves and meters on inlet and outlet pipework	67
Table 18: Preliminary pump station valve list	72
Table 19: Pipe material comparison for large pipelines	77
Table 20: Provisional valve list for inter-connecting pipeline	78
Table 21 Estimated preliminary costs	90

Table of Figures

Figure 1: Site location	9
Figure 2: Pacaltsdorp West bulk water supply scheme zones (GLS)	10
Figure 3 : Steady State Water Age in storage Tanks	15
Figure 4: Water Demand and Reservoir Capacity	18
Figure 5: Supply Zones	19
Figure 6: Existing PWR Zone Schematic (GLS Consulting, 2019)	20
Figure 7: Existing pumpstation PWT-PS-01	23
Figure 8: Flow control Valve Position for direct feed	27
Figure 9: Schematic of Pacaltsdorp West water supply scheme	30
Figure 10: EPANET model of existing reservoir and tower site for Scenario 0	33
Figure 11: Water age graphic - tower PWT-01 (Scenario 0, Run B)	34
Figure 12: Water age graphic - reservoir PWR-01 (Scenario 0, Run B)	34
Figure 13: Scenario 1 (5-year demand horizon)	35
Figure 14: Scenario 1 New reservoirs' site	36
Figure 15: Water age graphic – reservoir PWR-02 (Scenario 1, Run B)	38
Figure 16: Water age graphic – tower PWT-01 (Scenario 1, Run B)	38
Figure 17: Scenario 2 (10-year demand horizon)	39
Figure 18: Scenario 4 New Reservoir site	41
Figure 19 Phase 1 Scenario 1 Water age	42
Figure 20: PWR-02 Water age, PWR-02 Operating at full capacity	43
Figure 21: PWT-01 Water age	43
Figure 22: PWR-01 Water age	44
Figure 23: Indicative plan views for 2 x rectangular vs 2 x circular reservoir	46
Figure 24: Typical section for 2 x rectangular reservoirs	47
Figure 25: Typical section for 2 x circular reservoirs	47
Figure 26: General arrangement of reservoir site (incl. pump station and provision for future reservoir and towers)	52
Figure 27: Rendering of reservoir site showing proposed Phase 1A reservoir and pumpstation as well as future phases	52
Figure 28: Typical reservoir wall cross section showing water depth and total wall height	56
Figure 29: Sectional plan view of proposed new reservoir PWR-02 (showing columns and bases)	58
Figure 30: Typical section showing proposed detail for peripheral drain	59
Figure 31: Typical section through reservoir drainage channel (outlets to scour)	60
Figure 32: Partial section through reservoir showing foundation details	62

Figure 33: Typical section showing reservoir (bottom) inlet cast into mass concrete pipe block	63
Figure 34: Sectional view of reservoir inlet chamber	63
Figure 35: Typical detail showing reservoir outlet pipe cast into mass concrete pipe block	64
Figure 36: Sectional view of reservoir outlet chamber	64
Figure 37: Preliminary detail for emergency overflow	65
Figure 38: Sectional view of scour and emergency overflow chambers	66
Figure 39: Preliminary drainage pipe route from overflow and control chambers to discharge point (route highlighted)	66
Figure 40: Concept pumpstation layout (Phase 1A and 1B)	68
Figure 41: Section through concept pump house (showing extension that will be done under Phase 2)	70
Figure 42: Cross section through concept pump house showing pump pit below ground level	70
Figure 43: Preliminary layout of pump station pipework (showing pump sets 1 & 2 under Phase 1A)	72
Figure 44: George masterplan – draft layout for Pacaltdorp West reservoirs (GLS, 2022)	74
Figure 45: Proposed pipeline routes (pipelines in red)	75
Figure 46: Schematic of temporary linked pipelines A and B near the existing reservoir site	76
Figure 47: Potential site access road options	80
Figure 48: Future housing developments Pacaltdorp Erf 325 West (Delplan/JSA 2019)	82
Figure 49: Typical section of perimeter fence (GM fence specification)	83
Figure 50: Typical isometric projection of perimeter fence (GM fence specification)	83
Figure 51: Typical vehicle access gate (GM fence specification)	84
Figure 52: Typical Access gate (GM fence specification)	84

Annexures

Annexure A – Site Layout	A
Annexure B – Schematic	B
Annexure C – Water Demand Planning Horizon	C
Annexure D – Void	D
Annexure E – Programme	E
Annexure F – Masterplanning PACS WEST - Proposed Infrastructure	F
Annexure G – Masterplanning PACS WEST - GLS Site Layout	G
Annexure H – Demand Patterns	H
Annexure I – Pump Data	I
Annexure J – Geotechnical Report	J
Annexure K – GLM Guidelines Excerpts	K
Annexure L – Drawings	L

Appendices

AADD:	Average Annual Daily Demand
AASHTO:	American Association of State Highways and Transportation Officials
AC:	Asbestos Cement
BS:	British Standards
BWL:	Bottom Water Level
Cl ₂ :	Free chlorine
CPA:	Contract Price Adjustment
DC:	Development Contributions
DEADP:	Department of Environment Affairs and Development Planning
DN:	Nominal Diameter
ECSA:	Engineering Council of South Africa
FCV:	Flow Control Valves
FFL:	Finish Floor Level
FSL:	Full Supply Level
GLM:	George Local Municipality
GLS:	GLS Consulting
GRP:	Glass Reinforced Polyester
HDPE:	High Density Polyethylene
hrs:	Hours
IL:	Invert Level
kℓ:	Kilolitre
kℓ/d:	Kilolitre per day
kPa:	Kilopascal
ℓ/s:	litre per second
m:	Metre
MDD:	Maximum Dry Density
MOD:	Modified
mm:	Millimetre
Mℓ:	Megalitre

m msl:	Metres above Mean Sea Level
mPVC:	Microcellular Polyvinyl Chloride
NGL:	Natural Ground Level
NID:	Notice of Intent to Development (Heritage)
OGS:	Outeniqua Geotechnical Services
OHS:	Occupational Health and Safety
OHSS:	Occupational Health and Safety Specification (for Construction)
PE:	Polyethylene
PN:	Pressure Class/Rating
PDF:	Peak Day Factor
PHF:	Peak Hour Factor
PS:	Pump Station
PWF:	Peak Week Factor
PWR:	Pacaltsdorp West Reservoir (ground based)
PWT:	Pacaltsdorp West Water Tower
RPM:	Revolutions per minute
SANS:	South Africa National Standards
TAADD:	Total Average Annual Daily Demand
TBC:	To be confirmed
TWL:	Top Water Level
uPVC:	Unplasticized Polyvinyl Chloride
VAT:	Value Added Tax
WHO:	Water Health Organisation

1 Introduction

1.1 Background

Royal HaskoningDHV was appointed as a consultant to investigate, design and implement the upgrade of water networks and associated bulk facilities at the Pacaltsdorp West reservoirs. Additional water storage capacity is required to supplement the existing storage capacity to cater for the current demand and future developments, as well as for operational purposes to ensure that potable water can continue to be supplied to consumers during long maintenance and repair interruptions, as well as providing emergency storage for fire-fighting purposes. Sufficient storage capacity is also required to attenuate peak water demands so that the water treatment works can produce potable water at a constant rate without needing to adjust production rates.

The storage capacity of the existing Pacaltsdorp reservoir and elevated tank is insufficient to provide for the needs of the current population, and the situation will deteriorate as the population increases due to the development of low-cost housing and densification of the residential areas. The present and future water demands for Pacaltsdorp have been assessed, resulting in the proposal to increase storage capacity by 29 Ml in two phases, consisting of a 14.5 Ml reservoir in Phase 1 and 14.5 Ml reservoir in a future Phase 2, as well as increasing the elevated storage capacity with a 2.5 Ml to 3 Ml water tower and associated works as part of Phase 2.

George Municipality is implementing the necessary projects to supply water to these future developments and has recently increased the capacity of the Garden Route Dam to meet the future raw water demands for the George/Wilderness System as per the GLS Master Plan, 2021. The Pacaltsdorp West bulk water supply scheme upgrades, as described above, aligns with the raw water and water treatment capacity upgrades.

The purpose of this report is mainly the following:

- To describe the overall understanding of the existing system based on best available information, supplemented by site visits and discussions with the operators of the system.
- To provide a detailed description of the Works required under Phase 1, including the concept, the preliminary design criteria, flow control and the proposed implementation of the first phase.
- To provide details and recommendations for the preliminary design of the Phase 1A ground based 14.5 Ml reservoir, and with which to proceed, on approval to the detailed design stage.
- The report also briefly indicates and re-affirms the need for the future phases.

1.2 Study area

Pacaltsdorp is located south of George and south of the N2 national road, at the foot of the Outeniqua Mountains. The George Local Municipality is part of the Garden Route District Municipality. The existing Pacaltsdorp West Reservoir (PWR) is situated to the north-western side of Pacaltsdorp, adjacent to the Pacaltsdorp sports ground and the new PWR is on the southeast of the sport field. See **Figure 1** for the Site location, as well as **Annexure A**.



Figure 1: Site location

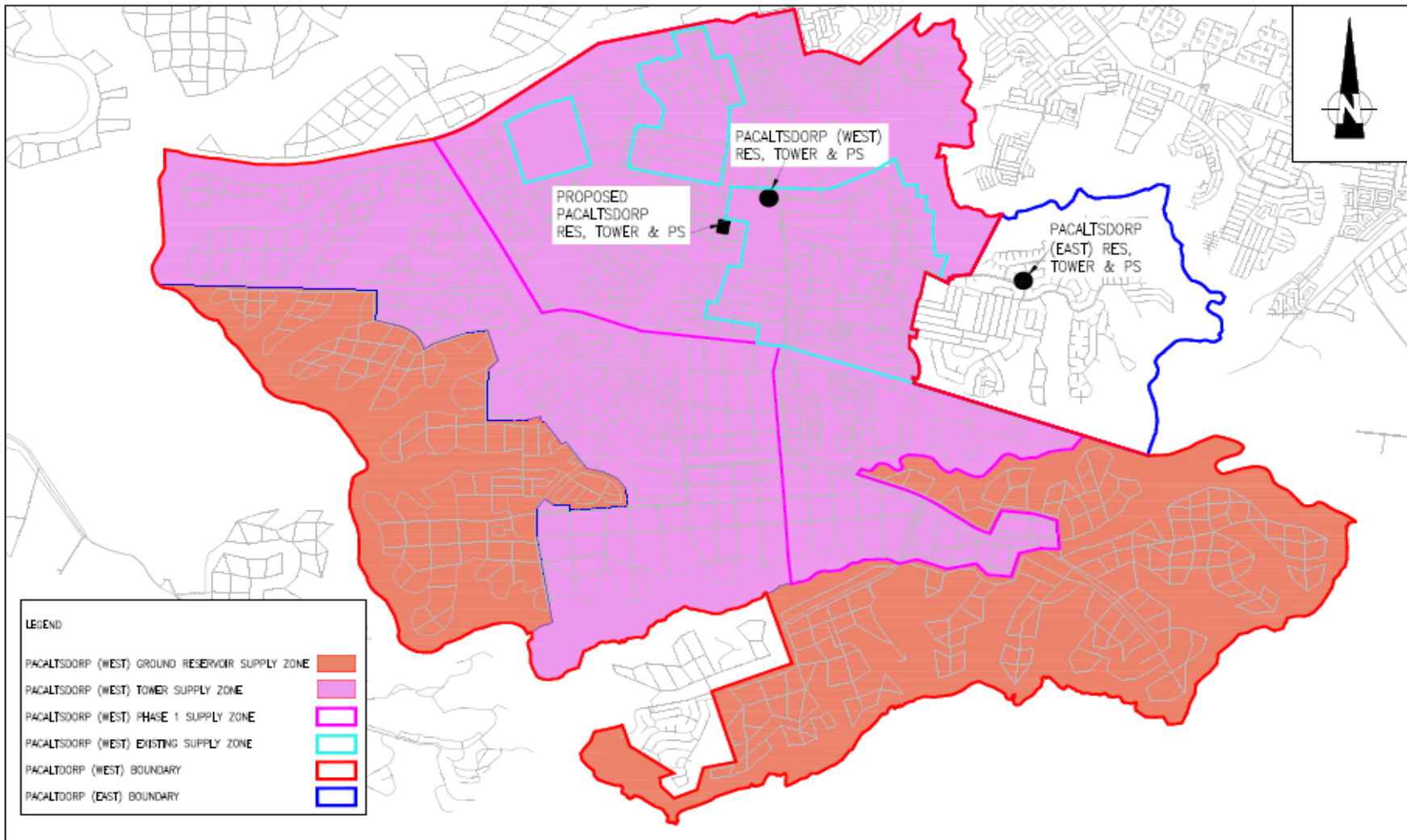

Figure 2: Pacaltsdorp West bulk water supply scheme zones (GLS)

Table 1 Project Location

Area	Latitude (S)	Longitude (E)
Pacaltsdorp West Reservoir (New)	34° 0'49.96"	22°26'46.94"
Pacaltsdorp West Reservoir (Existing)	34° 0'43.33"	22°26'59.39"

The new 14.5 Mℓ reservoir site was referred to as Option B in the Feasibility Report and will henceforth be referred to as “the new reservoir site”, as this option is now selected.

Refer to **Table 1** for the project location

The Site location was further detailed using the GLS data to show the different supply zones which are the tower zone and the reservoir zones. Refer to **Figure 2**.

1.3 Project objective and scope of work

The recent development of low-cost housing on serviced erven in the Pacaltsdorp area, as well as ongoing densification, has increased the water demand of the area, and resulted in a need for more water to be stored to meet the higher demand. The water storage capacity in the existing Pacaltsdorp West Reservoir (PWR) is now fully utilised, and therefore further capacity must be provided in the bulk water supply system for the future developments planned in the area.

George Municipality is implementing a phased project to provide the required reservoir storage capacity in the Pacaltsdorp West bulk water supply scheme. This report deals primarily with Phase 1 of the ultimate project.

The objective and scope of work of Phase 1 of the project is summarized below:

- A 14,5 Mℓ potable storage reservoir. This includes earthworks, concrete works and shuttering (reservoir and roof), structural steel and other metalwork, drainage and scour pipes, cut-ins and tie-ins, valve chambers (inlet-, outlet- and overflow structures), cable ducts, sundries, telemetry, access road and any other elements required for the complete construction.
- Interconnecting pipework between the existing reservoir, the water tower and new reservoir.
- Upgrades to the existing main supply pipelines as specified by the water reticulation master plans.
- Proposed flow control to reservoirs and existing tower.
- Evaluation of existing pump station transferring water from the existing reservoir to the balancing tower, including: verifying existing pump and system curves; verifying existing duty points; verifying upgrading requirements; upgrading recommendations if required; new pipework including mechanical upgrades; sub and superstructure upgrades.
- Legal and statutory requirements and approval for the implementation of the project.

1.4 Project demographic profile

The demographic of the supply area is summarised in **Table 2** below. This table was obtained from the latest updated Water Reticulation Master Plan (GLS Consultants, 2021). One must note that this includes both Phase 1 and Phase 2.

Table 2: Population Count

Development area	Phase	No of Households to be served (ref. GLS)	No. of individuals based on 3,23 persons per household
Existing Pacaltsdorp Occupied erven	Phase 1	4 648	15 013
Current and Planned erven – Inside Urban Edge	Phase 1	15 022	48 521
Current and Planned erven – Outside Urban Edge – Inside Southern bypass	Phase 1	3 898	12 591
Current and Planned erven – Outside Urban Edge – Outside Southern bypass	Phase 2	15 720	50 776
Total		39 288	126 900

2 Purpose of this report

The purpose of this report is:

- To describe the overall understanding of the existing system based on best available information, supplemented by site visits and discussions with the operators of the system.
- To provide a detailed description of the Works required under Phase 1, including the concept, the preliminary design criteria, flow control and the proposed implementation of the first phase.
- To provide details and recommendations for the preliminary design of the Phase 1A ground based 14.5 Ml reservoir, and with which to proceed, on approval to the detailed design stage.
- The report also briefly indicates and re-affirms the need for the future phases.

3 Guidelines for design analysis

The following guidelines provide the design criteria for the bulk water systems addressed in this report:

- Neighbourhood Planning and Design Guide (2019) Section J – Water Supply
- George Local Municipality (GLM) Civil Engineering Services standards and requirement for services (2016)
- GLM Development Contributions (DC) Guidelines – Development contributions for water (2022)

These guidelines are supplemented by correspondence and report excerpts from the GLM Water Masterplan by master planning consultants, GLS.

Correspondence and discussions with the GLM's water department are also considered. These are used to assess the capacity of the existing Pacaltsdorp bulk water supply system, and to address the appropriate upgrades for the Pacaltsdorp West water supply system, in line with the masterplan.

3.1 Flows and storage

Table 3 : Design criteria – flows and storage

Description	Criteria Values	Reference / Comment
Demand:		
Peak factors	Table WE-01	GLM guidelines
Pressure and flow criteria	Table WE-02	GLM guidelines
Reservoir:	Table WE-03	GLM guidelines
Emergency storage	24 h to 36 h x AADD	
Balancing volume	6 h to 12 h x AADD	
Total storage volume	30 h to 48 h x AADD	36 hrs as per GLS master plan
Bulk supply rate to reservoir	PWF to PDF x AADD	Refer to simulations (Section 6 of this report)
Bulk supply rate to tower (Direct feed)	Flow Control Valves values	GLS Master plan (Annexure F)
Water Tower:	Table WE-04	GLM guidelines
Tower storage volume	2 h to 6 h x AADD	Pump cycles/h
	2 h x AADD	With standby generator (Table J.16, Red Book)
Pump supply rate to tower	1,0 to 1,1 x PHF x AADD	No drawdown of the tower during pump cycle

* Table WE-01, Table WE-02, Table WE-03, Table WE-04 are attached as **Annexure K**

* Drawdown: lowering of the water level

3.2 Pipelines and pipework

The pipeline velocity and unit head loss criteria, and pipeline material selection options are as follows:

Table 4: Pipelines and pipework design guidelines

Description	Criteria Values	Reference/Comment
Pipe flow velocity:		GLM guidelines (operational criteria)
Preferred limit	1,8 m/s	
Maximum	2,2 m/s	
Unit head loss (max):		
DN1000 – DN500	3 m/km	(suggested criteria)
DN450 – DN200	8 m/km	
DN150 and smaller	10 m/km	
Pipe Materials:		
DN1000 – DN300	HDPE PE100 PN16	SANS 4427 (all parts)
	GRP Class 16	SANS 1748-1
DN300 or smaller	uPVC Class 16	SANS 966-1
	mPVC Class 16	SANS 966-2
	HDPE PE100 PN16	SANS 4427

3.3 Water quality and water age

3.3.1 Guidelines and standards

In this report, water quality is discussed only in the context of the free chlorine Cl_2 parameter. The upper limit for this parameter is 5,0 mg/l, as defined in SANS 241-1:2015, Table 2.

The WHO Guidelines for Drinking-water Quality (4th Edition, 2017) recommend the same upper limit and give the lower limit in the system as between 0,5 mg/l and 0,2 mg/l, as follows:

For effective disinfection, there should be a residual concentration of free chlorine of $\geq 0,5$ mg/l after at least 30 min contact time at $\text{pH} < 8,0$. A chlorine residual should be maintained throughout the distribution system. At the point of delivery, the minimum residual concentration of free chlorine should be 0,2 mg/l.

3.3.2 Modelling Methodology

In modelling the water quality in a bulk distribution system, the water age can be used as a surrogate for water quality. The water age can be accurately determined in the model, but, to accurately model water quality, the system model requires calibration with actual values.

The relationship between water quality (residual/free chlorine) and water age is dependent on the baseline water quality, the water quality of any incoming flows, and the condition and properties of the pipes and reservoirs in the bulk distribution system.

Therefore, in this design, **water age is used as a surrogate, or proxy, for water quality**, as it requires no assumptions except the initial condition (age) of the water at the source/s reservoirs (WTW reservoirs). This also simplifies the water quality model.

For example, if we consider 1 Ml of water in storage that has a fraction X of its volume replaced with zero age water, at the end of each day:

The water age in hours at the end of day k, A(k): $A(k+1) = (A(k) + 24) \cdot (1-X)$
 which has a long-term steady state age, S: $S = 24 \cdot (1-X) / X$

This means that:

For the fraction of water replaced each day X: $X = 33\%$, then $S = 48$ hours (2 days)
 $X = 20\%$, then $S = 96$ hours (4 days)
 $X = 100\%$, then $S = 0$ hrs (0 days)

And so on, as illustrated in the graph below.

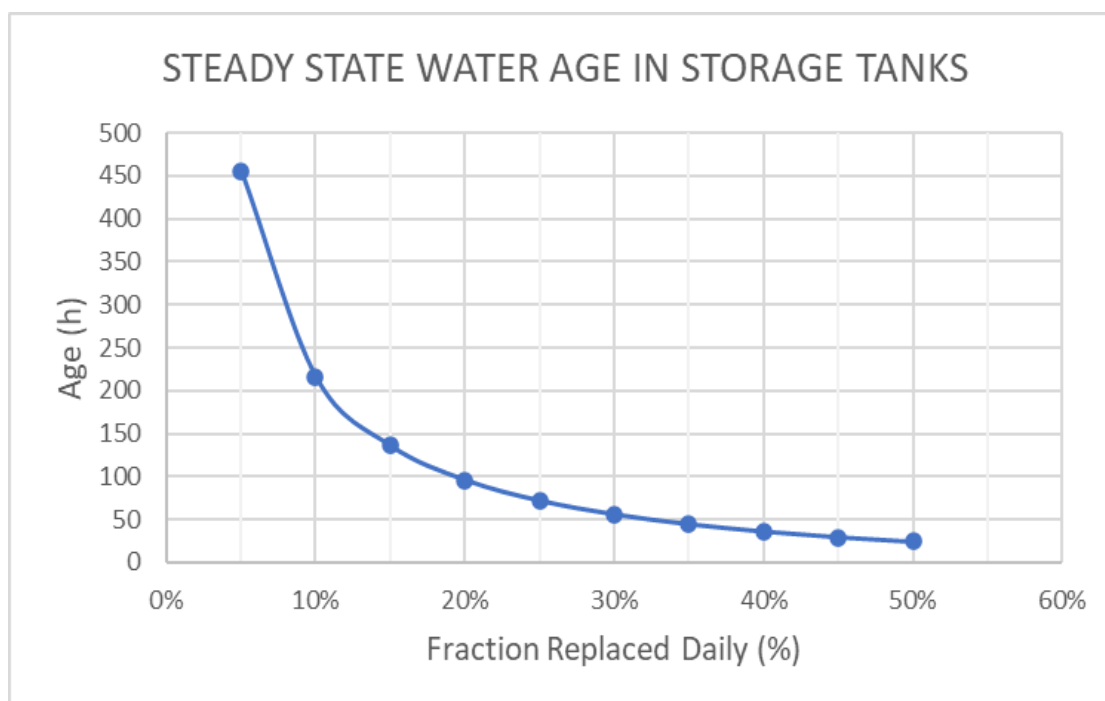

Figure 3 : Steady State Water Age in storage Tanks

For this project, the following water age limit is proposed, based on the free chlorine guideline values listed in the table below:

Table 5 : Water Quality design criteria

Description	Criteria Values	Reference/Comment
Water quality:	5,0 mg/l max at WTW	SANS241
(free chlorine Cl ₂)	0,5 mg/l min at reservoirs	WHO
	0,2 mg/l min at consumer	WHO
Water age:	4 days preferred	Adopted for design purposes
	< 7 days maximum	Adopted for design purposes

3.3.3 Interpretation of results

- i. In summary then, to maintain a water age of less than 7 days (168 hours) in the storage reservoirs, the required fraction to be replaced daily figure is thus **approximately 10%-15% of AADD, when the reservoir system is operating at full utilisation.**
- ii. However, it must be noted that, when a reservoir is first built and has excess capacity, **the required fraction to be replaced is then in the order of 50% of AADD.** (This is illustrated in the results of the hydraulic and water quality analyses that are presented in **section 6.3** of the report.)
- iii. An alternative to the option in (ii) above, the Municipality can consider operating the reservoir at lower levels for the initial years.

4 Water demand

For the water usage analysis, the AADD (annual average daily demand) for the existing, newly developed, infill areas, future planned areas and fully occupied areas was calculated using an average domestic consumption of between 188 ℓ/day/erf and 1 500 ℓ/day/erf depending on the land use. These data were obtained from GLS Consulting Master Plan 2022, Pacaltsdorp West Area.

The demand projections in **Table 6** below were taken from the water masterplan, which is based on the latest data available on population growth, economic growth, growth in number of consumer units, income level considerations, level of service required for each area to be serviced and changes in consumption per consumption unit (GLS Consulting Master Plan, 2022). The table was slightly modified to show the demand horizon.

For the purpose of this report, the AADD and the TAADD (referred to in the Red Book) are taken as the same value (TAADD referred to in the Red Book, includes for real losses). In this report, the figures for AADD are used as supplied by GLS (Excel file: “Pacaltsdorp Future AADD Summary (m2021-12).xlsx”, attached to GLS email 21 April 2022, George IMQS: Pacaltsdorp 14.5 Mℓ Reservoir discussion).

Table 6: Demand Horizon and Reservoir Capacity

Development Areas	Households served	Population served *	AADD	Required reservoir capacity	Required reservoir capacity – Cumulative
	(No)	(Persons)	(kℓ/d)	(kℓ)	(kℓ)
Existing Pacaltsdorp occupied	4 648	15 014	2 078	3 117	3 117
Inside Urban Edge and Southern Bypass					
Planning Horizon	0 – 5 Years				
Occupied			718	1 077	
Europa	507	1 638	254	380	4 194
Pacaltsdorp Densification	1 148	3 709	574	861	4 574
Pacaltsdorp Erf 142	12	39	5	8	5 435
Pacaltsdorp Erf 219-220	108	349	48	72	5 443
Pacaltsdorp Erf 277	48	156	21	32	5 515
Pacaltsdorp Ext. 1A	285	921	157	235	5 547
Subtotal	2 108	6 812	1 777	2 666	5 782
Planning Horizon	5 – 10 Years				
Hansmoeskraal (1a)	361	1 167	220	331	
Mooikloof (1)	44	143	20	29	6 113
Pacaltsdorp Erf 2838a	137	443	62	92	6 143
Pacaltsdorp Erf 2838b	92	298	41	61	6 235
Pacaltsdorp Erf 2838c	15	49	10	15	6 296
Pacaltsdorp Erf 325 (West)	6 909	22 317	2 687	4 030	6 311
Pacaltsdorp Erf 7382	86	277	57	86	10 342
Pacaltsdorp Erf 7452	56	181	25	37	10 427

Development Areas	Households served	Population served *	AADD	Required reservoir capacity	Required reservoir capacity – Cumulative
	(No)	(Persons)	(kℓ/d)	(kℓ)	(kℓ)
Hansmoeskraal 202/67	14	46	21	32	10 465
Subtotal	7 714	24 921	3 143	4 714	10 496
Planning Horizon	10 – 15 Years				
Rivendale	2 645	8 544	1 176	1 763	
Subtotal	2 645	8 544	1 176	1 763	12 260
Planning Horizon	15 – 20 Years				
Pacaltsdorp Erf 323	1 426	4 606	317	475	
Pacaltsdorp Ext.3A	1 029	3 324	686	1 029	12 735
Pacaltsdorp Ext.3B	114	369	76	114	13 764
Subtotal	2 569	8 299	1 079	1 618	13 878
Outside Southern Bypass					
Planning Horizon	20 – 25 Years				
Gwayang River Estate (1)	2 096	6 771	1 048	1 572	
Hansmoeskraal (1c)	48	156	29	44	15 450
Hansmoeskraal 202/58-59-61	295	953	393	590	15 494
Hansmoeskraal 202/8-9	299	966	150	224	16 084
Subtotal	2 738	8 846	1 620	2 430	16 308
Planning Horizon	25 – 30 Years				
Hansmoeskraal (1b)	146	472	89	134	
Hansmoeskraal (2)	1 014	3 276	507	761	16 442
Gwayang River Estate (2)	2 096	6 771	1 048	1 572	17 202
Hansmoeskraal 202/41	600	1 938	433	650	18 774
Subtotal	3 856	12 457	2 077	3 116	19 424
Planning Horizon	30 – 35 Years				
Hansmoeskraal (4)	48	156	72	108	19 532
Subtotal	48	156	72	108	19 532
Planning Horizon	35 – 40 Years				
Hansmoeskraal (3)	201	650	301	452	
Hansmoeskraal (6)	2 350	7 591	1 175	1 763	19 985
Hansmoeskraal (7)	1 395	4 506	698	1 046	21 747
Subtotal	3 946	12 747	2 174	3 261	22 793
Planning Horizon	Years > 40				
Buffelsfontein (1)	349	1 128	175	262	
Buffelsfontein (2)	1 190	3 844	595	893	23 055
Gwayang (1)	2 593	8 376	1 297	1 945	23 948
Gwayang (2)	588	1 900	294	441	25 892

Development Areas	Households served (No)	Population served * (Persons)	AADD (kℓ/d)	Required reservoir capacity (kℓ)	Required reservoir capacity – Cumulative (kℓ)
Gwyang River Estate (3)	3 854	12 449	1 927	2 891	26 333
Hansmoeskraal (5)	442	1 428	663	995	29 224
Subtotal	9 016	29 125	4 950	7 425	30 218
Total	39 288	126 921	20 145	30 218	

The reservoir storage capacity required in the Pacaltsdorp West Reservoir Zone follows from the water demand figures (AADD) that were calculated for the zone and has also been tabulated and shown in **Table 7** below.

Table 7: Reservoir Storage Capacity

Pacaltsdorp (West) Reservoir Zone	Reservoir Required Capacity kℓ	Reservoir Designed Capacity kℓ	Tower Required Capacity kℓ	Tower Designed Capacity kℓ
Existing Capacity	3 117	3 000	346	340
Modelled as Scenario 0				
Phase 1: New Capacity	13 877	14 500	1 196	1 250
Modelled as Scenario 1, 2				
Phase 2: New Capacity	16 341	14 500	1 816	1 750
Modelled as Scenario 3, 4				
Total Storage PWR and PWT (50-year horizon)	30 218	32 000	3 358	3 340

*Reservoir required capacity is based on 36 hours AADD storage

*Tower required capacity is based on 4hours AADD storage

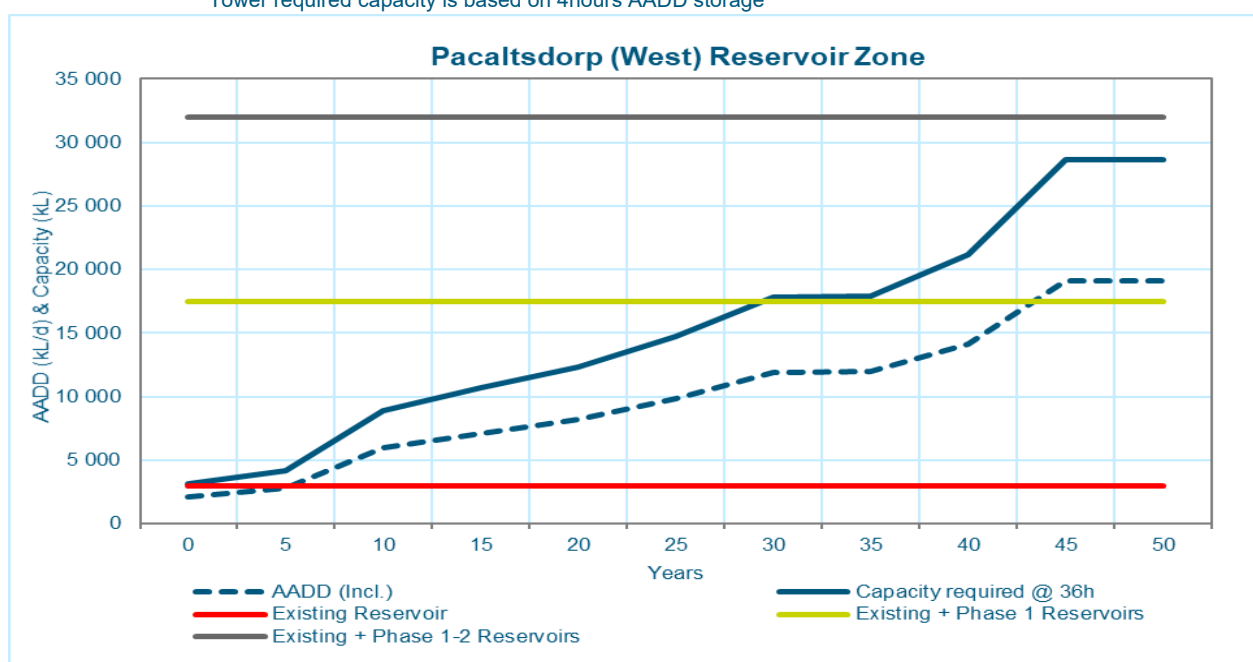

Figure 4: Water Demand and Reservoir Capacity

This total storage includes both Phase 1 and Phase 2 and their associated elevated storage capacity that supplies the tower zone (PWT).

Figure 4 shows a graph of the water demand for the 50-year demand horizon and when the required capacity will be required.

The different supply zones which are PWT zones (tower zones) and PWR zones (reservoir zones) are illustrated on **Figure 5** below.

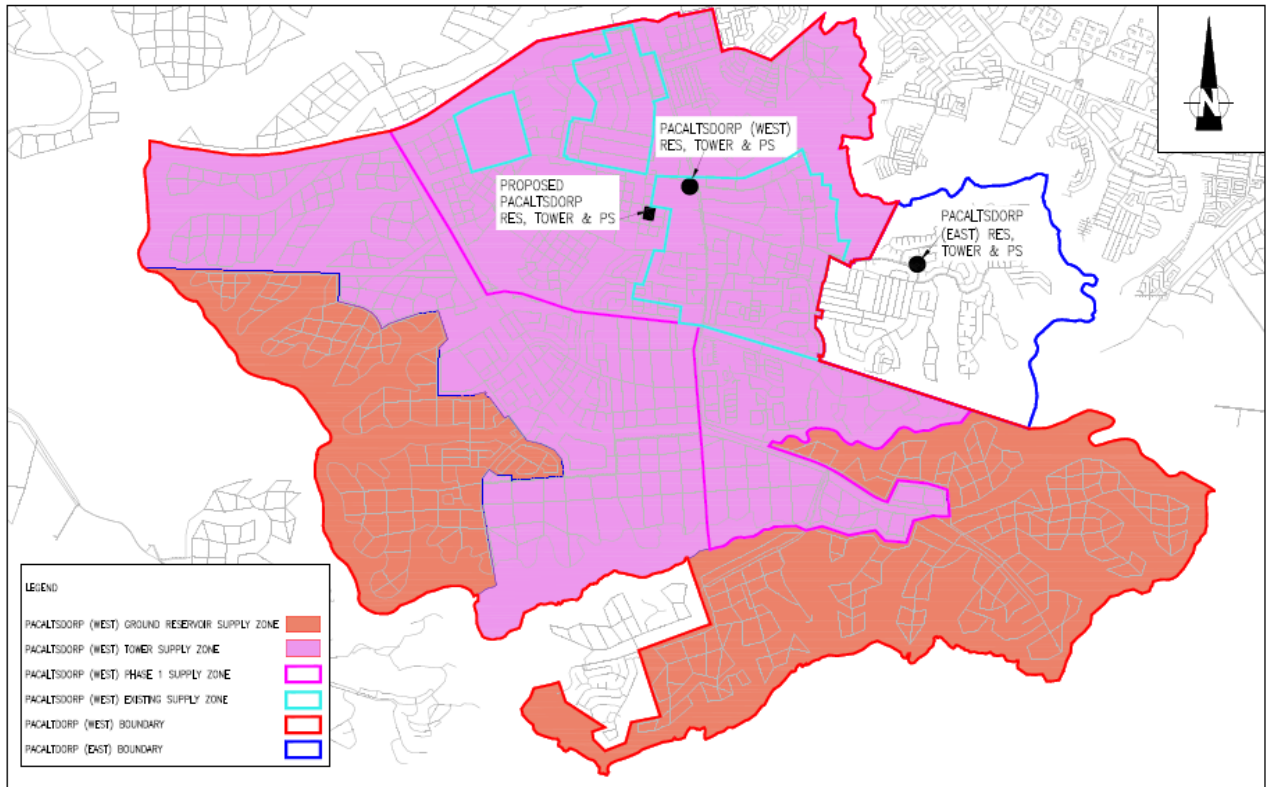

Figure 5: Supply Zones

5 Existing Infrastructure

The existing reservoir site is located on the north-western side of Pacaltsdorp, adjacent the Pacaltsdorp sports ground. Information from the available record drawings, and from site visits and discussions with the operators are summarized in the sections below. The schematic summary of the existing PWR zone infrastructure at the site is shown in **Figure 6** below.

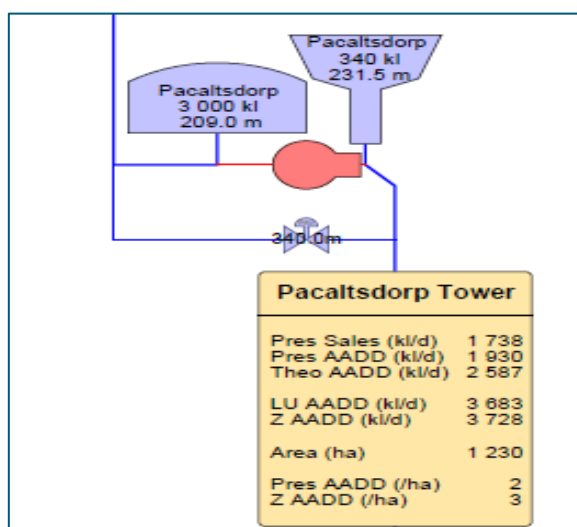

Figure 6: Existing PWR Zone Schematic (GLS Consulting, 2019)

Most of the details of the existing infrastructure at the reservoir site have been obtained from drawings by Ninham Shand, and supplied by Zutari Consulting. These drawings, supplied in PDF and CAD formats, and dated April 1999, cover the existing 3,0 Mℓ potable water reservoir (PWR-01), the 340 kℓ elevated tower (PWT-01), the pump station (PWT-PS-01), and the original inlet and outlet water pipelines at the existing site.

The existing reservoir has a bottom DN250 inlet pipe with a riser pipe to reservoir TWL.

5.1 Bulk water supply system

The existing Pacaltsdorp reservoir is supplied with water, from the command reservoirs at the Old George Water Treatment Works, by two roughly parallel pipelines.

The main bulk water supply pipeline, over the first half of the route to Pacaltsdorp, is a DN1 000 mm Glass Reinforced Polymer (GRP) pipeline. The pipeline has cross connections to other bulk pipelines, and the diameter changes to DN800, DN1 000, and back to DN600, as it traverses the town. The second half of the route, referred to as the “Western Line”, is a DN600 mm GRP pipeline that crosses the N2 national road, and delivers water to the Pacaltsdorp reservoir site.

The DN600 GRP reduces to a DN300 on the existing reservoir site just after a chamber and continues for a short length until it connects to the “older” DN300 bulk pipeline that feeds the reservoir.

The other bulk water supply pipeline is an older DN300 mm Asbestos Cement (AC) pipeline which feeds through the George South zone to Pacaltsdorp. This AC pipeline has now exceeded its rated pressure design life, and may not be able to reliably provide an alternative supply to the Pacaltsdorp West zone going forward.

The (DN600) Western Line was installed to provide the total ultimate demand flow to the PWR system, and the old DN300 line is presently used as a back-up supply. The Site operator indicates that the inlet valve to the reservoir is throttled to reduce the flow into the reservoir due to the high residual pressure available at most times in the bulk supply system (up to 9 bar).

The George water master plan (GLS) recommends that the DN300 AC pipeline be converted in future to an additional (lower) pressure gravity feed from the existing elevated tank (PWT-01). The working pressures would then be reduced to approximately 3-6 bar in that pipeline. However, provision will be made for the pipeline to be able to feed the tower zone as an emergency supply in a case where the DN600 fails.

We note that the relatively new DN600 Western Line has experienced numerous pipe bursts since being brought into operation, and that the older DN300 pipeline is still often required to provide the back-up supply.

5.2 Reservoir PWR-01

The existing Pacaltsdorp West reservoir (PWR-01), currently supplying the Pacaltsdorp West zone, has a capacity of 3,0 Ml. This circular concrete reservoir has the following top and bottom water levels:

TWL* 208,95 mMSL

BWL* 202,75 mMSL

The reservoir is fed via DN300 pipeline with a DN150 flowmeter in a control chamber, which is then reduced to a DN250 inlet pipe entering the reservoir at the bottom, but the water is discharged above TWL.

The reservoir has an internal diameter of 25 m, and an effective depth of 6,2 m.

This reservoir provides a dedicated supply to the elevated circular concrete water tower (PWT-01), which is situated adjacent to the reservoir. The reservoir feeds into the adjacent pump station (PWT-PS-01) which then lifts the water into the tower.

Note that this PWR-01 reservoir does not feed directly to the reticulation system (i.e. consumer connections) at all, and only supplies water to the tower, via the pump station.

The existing reservoir storage capacity (volumes) for the supply area equates to approximately 36 hours of the current AADD (2 078 m³ x 1,5). This is in line with the George Water masterplan as carried out by GLS Consultants, where an equivalent storage of 36 hours of AADD has been adopted for the Pacaltsdorp West bulk water supply system. This is in line with Table WE-03 of the GLM guidelines and within the values for reservoir storage given in the “Red Book” Guidelines.

The “Red Book” Guidelines suggest values between 48 hours and 24 hours of annual average daily demand, and where 24 hours will suffice, depending on the situation (user demands, redundancy in the supply system, and other primary storage).

Therefore, at 36 hours, the storage capacity of the existing 3 Ml reservoir is considered to be fully taken up at present, and further water storage provision is required going forward for any future developments.

*Note – levels require accurate engineering survey to confirm actual overflow and top water levels.

5.3 Water Tower PWT-01

Water from the water tower is gravity fed into the Pacaltsdorp West area on demand.

The Tower is fed from the reservoir (PWR-01) via a suction pipe of which the first section is DN300 and which increases to DN400 through the pump station (PWT-PS-01) and pumped in a DN250 rising main to the Water Tower (PWT-01).

The existing pipework allows to supply the water tower directly from the incoming DN300 pipeline within the reservoir site, but this option is not used currently (pers. communication with Site operator).

The water tower PWT-01 has a capacity of 0,340 Ml **, according to the George masterplan documents.

Top water level TWL**	231,14 m msl (MPlan TWL given as 231,50m msl)
Bottom water level BWL**	224,68 m msl
Ground level NGL	203,45 m msl
Tower base floor level	203,95 m msl (VPM 2019 survey)

*** Note – the storage levels require accurate engineering survey to confirm actual overflow, top and bottom water levels, as well as the internal dimensions of the storage tank – for precise co-ordination, as well as to confirm the tower's actual storage capacity.*

We note that the towers' original DN150 inlet and outlet pipes, that passed through the base of the towers' elevated storage tank, have been re-purposed to both serve as outlet pipes that feed the towers' gravity zone. The original inlet pipe was replaced by the present galvanised steel DN250 rising main that passes up through the access shaft in the storage tank, and discharges as a top inlet.

As listed in Table 3, the nominal capacity required for elevated storage, based on the typical period involved in power failures, is given in **Table J.16 (Red Book)**, as 2 hours at AADD - if there is standby power (e.g. a diesel driven generator in this case).

The existing Tower has storage time of approximately 4 hours at current AADD flows and can therefore be used for the short term to medium period to supply the present PWT zone as the demands increase.

However, it should be noted that the tower must supply both balancing storage and emergency storage. Therefore, the level at which the tower storage is operated becomes more critical as the demands increase over time. This is particularly important to consider if the number of fire flow events, or the fire risk category of the zone, is increased.

If the current PWT (and PWR) zone's fire risk category is, say, moderate risk 2 (cluster and low-income housing, high rise flats ≤ three storey), the required fire storage is 2 h x 25 l/s = 180 kl.

Therefore, based on the reported size of the existing tower at 340 kl, slightly more than 50% is required for emergency (fire) storage. This will play an important part on the operating rules for the existing and future tower as the demands in the PWT zone increase. (See hydraulic model assumptions in the following sections).

5.4 Pump Station PWT-PS-01

The existing pumpstation (PWT-PS-01) building is a conventional brickwork structure with concrete beams to support the lifting equipment, and wooden roof trusses with a tiled roof.

A generator room was added to the east end of the building, as shown in the photograph (see **Figure 7**).

Inside the building, there is space provided to allow for the installation of two more pumps, as well suction pipework connections for two further pumps on the suction manifold.



Figure 7: Existing pumpstation PWT-PS-01

The pumpstation is equipped with a set of 2 pumps, one duty and one standby. The water is pumped from the existing ground reservoir (PWR-01) to the Tower whenever the Water level in the tower reaches the set point level.

Existing pumping equipment in the existing pumpstation PWT-PS-01:

Table 8: Pumping Equipment Details

Description	Details	Comment/s
Pumpstation:		
Pumps	KSB Etanorm 125-100-200	2 No. pumps and electric motors
Impeller	219 mm	
Configuration	1 duty, 1 standby	(2 x 100%)
Nominal Duty	89 l/s (320 m ³ /h) @ 54 m	At BEP (best efficiency point)
Max Head	63,2 m	No flow (Q=0)
Motor	48 kW*	*To be confirmed

Description	Details	Comment/s
Rpm	2 900*	*To be confirmed
Drives	Schneider Altistart 48	Soft starter (Pumps run at constant speed)
Tower:		
Level Sensor	TBC	Ultrasonic
Pump Start Level	4,0 m* water depth	TBC (4,17 reading on site soon after pump start)
Pump Stop Level	6,0 m* water depth	*To be confirmed (TBC)
Float Switches	High level	Pump stop
	Low level	Alarm - TBC
Reservoir:		
Level Sensor	TBC - Mobrey ultra-sonic	MCU900 Display unit
Standby Generator	Marelli 250kVA	Model MJB 250 LA4
	Perkins 1106A-70TA	

The applicable pump data sheet is included in [Annexure I](#). The actual data will be obtained by the pump supplier in the detailed design phase.

With the construction of the new Pump station, the reliance on existing Pump Station will be reduced and no design upgrade (duty) will be required in Phase 1A except where pipework connections are required which are mainly outside the pump station building.

It is to note that, no function conditional assessment was done. However, an inspection visit was conducted of the pump station during the feasibility study phase. Therefore, a proposal to do function conditional assessment will be submitted to GM to carry out this work during the details design stage. This will also inform on refurbishment required if any.

6 Scheme development

As described above in the introduction and background section, the Pacaltsdorp West water supply scheme is to be developed in two main phases, with Phase 1 catering for the short to medium term design horizon (10-15 years), and Phase 2 for the long-term design horizon up to 50 years.

6.1 Scheme phases and modelled scenarios

This report deals with Phase 1A, although the next phase and the overall scheme must also be considered so that future phases can be accommodated.

In this preliminary design, we consider the increasing demands in the supply area and the design of the infrastructure for Phase 1A, to meet these demands in the short term. The overview of the ultimate scheme with the estimated demands as per the masterplan, is indicated in the graphic below, together with the implementation phases, and the scenarios that are modelled.

Table 9 Scheme phases and modelled scenarios

MPlan Demands AADD(Ml/d)	2,08	3,86	6,99	8,17	9,25	10,87	12,95	13,02	15,20	20,15	20,15
Scenario	SC 0	SC 1	SC 2			SC 3		SC 4			
Construction Phases											
Reservoir 14,5 Ml + PS-02 Ph.A		1A									
Tower 1, 25Ml PWT-02			1B								
Reservoir 14,5 Ml + PS-02 Ph.B						2A					
Tower 1,75 Ml PWT-03							2B				
Overall Phases	1					2					
	Inside Urban Edge + Southern Bypass					Outside Southern Bypass					

The modelled scenarios take into account the demands, flows, storage capacities and the proposed flow controls of the existing and new reservoirs and towers that are planned. These scenarios were useful in terms of determining when the upgrade will be required at the different phases.

Phase 1 consists of scenario 0, scenario 1, and scenario 2 and the second phase will consist of scenarios 3 and 4. See **Table 10** for the breakdown of the time scales and the reservoir storage requirements covered by each scenario. Phase 1 is to be implemented in two phases which are Phase 1A and Phase 1B.

Phase 1A is for the proposed new 14,5 Ml reservoir and a first phase of a new pumpstation which will supply the existing tower, including all the required interconnecting pipework.

For Phase 1B, we propose the implementation of a 1,25 Mℓ sized tower (PWT-02) instead of a 2,5 Mℓ sized tower. This will also include a small upgrade of the new pump station which will now pump to the new tower.

As discussed in the previous section, the tower must supply both balancing storage and emergency storage. Allowing for this, and any upgraded fire risk category for the zone, will play an important part in the operating rules for the existing and future tower as the demands in the PWT zone increase. A 4 hour storage time for the Tower was used for the sizing of the Tower.

Table 10 : Phases and scenarios – water demands and storage requirements over time

Phase (P) / Scenario (S)		Storage Reservoir PWR		Tower PWT		
		AADD	Storage time 36 hrs	AADD	Storage time	
					2,0 hrs	4,0 hrs
P / S	Year	kℓ/d	kℓ	kℓ/d	kℓ	
P1 / S0	0	2 078	3 117	2 078	173	346
P1 / S1	5	3 855	5 782	3 855	321	642
P1 / S2	10	6 997	10 496	6 976	583	1 166
	15	8 173	12 259	8 152	681	1 362
	20	9 252	13 877	9 231	771	1 542
P2 / S3	25	10 872	16 308	10 851	906	1 812
P2 / S4	30	12 949	19 424	11 988	1 079	2 158
	35	13 021	19 532	11 988	1 085	2 170
	40	15 195	22 793	13 860	1 266	2 533
P2 / S4	45	20 145	30 218	15 451	1 679	3 358
	50	20 145	30 218	15 451	1 679	3 358

6.1.1 Phase 1: Current and up to 10-year demand scenarios

Phase 1 consists of three scenarios, which includes the current situation, the 5-year scenario with the addition of the first 14,5 Mℓ reservoir (PWR-02) and the 10-year scenario with the addition of the new elevated tower (PWT-02).

6.1.1.1 Phase 1, Scenario 0 (Current)

- Water Demand: Existing/current (2022) situation. The current demand or Year zero demand is 2 078 kℓ/d as per **Table 10**.
- Infrastructure: No new infrastructure. This is the current situation, and the capacities of both the reservoir PWR-01, and the tower PWT-01, are fully taken up by the preferred storage criteria of 36 h reservoir storage and current 4 h tower storage of AADD respectively.
- Supply zones: The existing zone (PWT-Zone-01) is supplied directly by existing Tower (PWT-01). The existing tower is currently running at maximum capacity and giving less than four hours storage during peak time but can still provide more than the minimum of two hours

storage. The water is pumped to PWT-01 from the existing reservoir (PWR-01) through the existing pump station (PWT-PS-01).

- The tower pumpstation (PWT-PS-01) operating rule is aimed at maintaining at least 60% of the tower capacity for emergency (firefighting) – this relates to operating the tower between 4,0m (pump start) and 6,5m (pump stop) water depths.
- Direct feed from the bulk supply if/when utilised will be limited to keep the PWR-01 (3 Mℓ) reservoir water age at approximately 4 days (less than 7 days, even during the lower seasonal peak days).
- This direct feed flow is controlled at the flow control valve which is located on direct feed bulk and connecting between the incoming bulk supply and the rising main from the pumpstation PWT-PS-01 to the tower PWT-01, See figure 8.

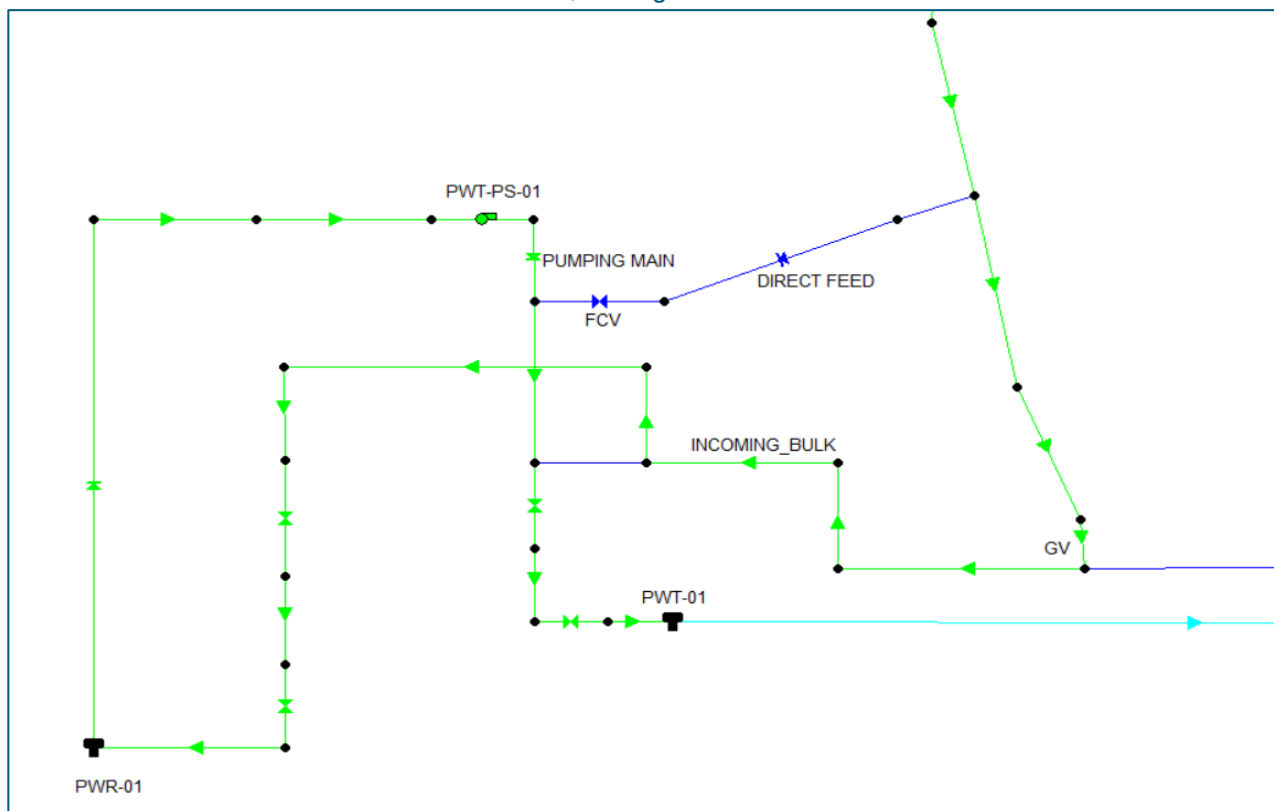

Figure 8: Flow control Valve Position for direct feed

6.1.1.2 Phase 1A, Scenario 1 (5-year demand horizon)

- Water demand: This scenario deals with the five-year water demand horizon. The AADD is 3 855 kℓ/d.
- Infrastructure needed: Construction of a 14,5Mℓ reservoir (PWR-02), pumpstation (PWT-PS-02), and pipelines connecting the two reservoir sites. The new PWT-02 pump station mechanical and electrical equipment will initially (Phase 1A) be sized for Scenario 1 flows, and will be upgraded at a later stage (Phase 1B) when it is required to pump to the future new tower (PWT-02).
- Supply zone: The entire zone PWT-Zone-01 is fed directly from the existing tower (PWT-01). Due to its limited storage volume, the tower PWT-01 can only provide approximately two

hours of storage. Therefore, the inflows must be increased, particularly during peak flow periods, to maintain an acceptable emergency storage level in the tower.

- There will, however, be excess ground storage in the two reservoirs (existing PWR-01 and the new PWR-02) during this phase. Water is to be pumped from both reservoirs to the existing tower PWT-01, by alternating the duty between the two pump stations, PWT-PS-01 and PWT-PS-02.
- As for Scenario 0, the tower pumpstation (PWT-PS-01) operating rule is aimed at maintaining 60% of the tower capacity for emergency (firefighting) – this relates to operating the tower between 4,0m (pump start) and 6,5m (pump stop) water depths.
- Direct feed from the bulk supply to the Tower is to be limited so that the target water age of both reservoirs (the existing PWR-01 and the new PWR-02) is maintained at approximately 4 days (and less than 7 days, even during the lower seasonal peak days).
- Similarly to Scenario 0, the direct feed flow is controlled at the new flow control valve which is to be located on the new connection between the incoming bulk supply pipeline and the rising main from the pumpstation PWT-PS-01 to the tower PWT-01 as shown in figure 8.
- Due to the ultimate sizing of the new reservoir PWT-02 for a 20-25 year design horizon, and the relatively low demands estimated for the 5-year design horizon in this Scenario 1, it may be necessary to initially route all of the incoming water through the new reservoir, or to operate the new reservoir at, say, 50% capacity. This is to maintain a reasonable (less than 7 days) water age in the new reservoir. The water age issue would then improve and resolve itself over time as the demand increases.

6.1.1.3 Phase 1B, Scenario 2 (10-year demand horizon)

- Water demand: This scenario is for the ten-year water demand horizon up to year 20. The AADD increases from an estimated 6 997 kℓ/d to 9 252 kℓ/d in this period.
- Infrastructure needed: Construction of a new 1,25 Mℓ tower (PWT-02), and upgrade the pumping capacity of PWT-PS-02 to supply the new tower. The new tower will provide the required four-hour storage time for the year 20 demand horizon.
- Supply zone: The combined PWT (tower) zone is to be supplied by the existing tower and the new tower, whose top water levels are designed to be the same. The PWT zone is split into three sub-zones, tower zone 1 (PWT-Zone-01) which can still be supplied exclusively from PWT-01 if necessary, and the new tower zones 2 and 3, which can be supplied exclusively from the new tower PWT-02, as required.

6.1.2 Phase 2 Future demand scenarios

Phase 2 of the Pacaltsdorp West water supply scheme takes the scheme up to the long term development planning horizon of 50 years.

6.1.2.1 Phase 2A, Scenario 3 (25-year demand horizon)

- Water demand: for the year 20 up to year 25 water demand horizon. The AADD for this scenario increases up to 10 872 kℓ/d.

- Infrastructure needed: Construction of the second 14,5 Ml reservoir (PWR-03) and further upgrading of pump station PWT-PS-02.
- Supply zones: The PWT tower zones are to be supplied from tower PWT-01 and PWT-02 respectively, as described above. In addition, the lower lying areas to the south and west, are to be supplied directly from the ground reservoirs PWR-02 and PWR-01, as per the George water masterplan.
- During this period the combined elevated tower storage capacity will provide between four hours and two hours (minimum) of AADD, depending on the actual demands. The implementation of the next phase of elevated storage will depend on the actual and projected demand growth for the supply area.

6.1.2.2 Phase 2B, Scenario 4 (50-year demand horizon)

- Water demand: From year 25 up to year 50 demand horizon, the projected AADD increases from an estimated 12 949 kℓ/d to 20 145 kℓ/d.
- Infrastructure needed: Construction of a second 1,25 Ml tower, PWT-03, is required after year 25, as the towers PWT-01 and PWT-02 will not be able to give the full four hours storage at all times. However, we note that these first two towers will be able to deliver at least two hours storage until approximately year 40.
- Depending on the implementation preference, tower PWT-03 can be implemented at scenario 3. For now, the hydraulic model deals with scenario 3 and scenario 4 together as one.
- Supply zone: The completed scheme will consist of the tower zones being supplied from the three towers, and the reservoir zones being fed from the two 14,5 Ml reservoirs. It will also be possible to link the existing 3 Ml reservoir PWR-01 to the reservoir zone, should this be desirable when Phase 2 is designed.

6.2 Schematic layout

A schematic layout, **figure 9**, of the Pacaltsdorp West water supply system shows the layout of the system and the main design elements, as well as the demands and demand patterns applied, as the supply area expands.

A larger version of the schematic is provided in [Annexure B](#).

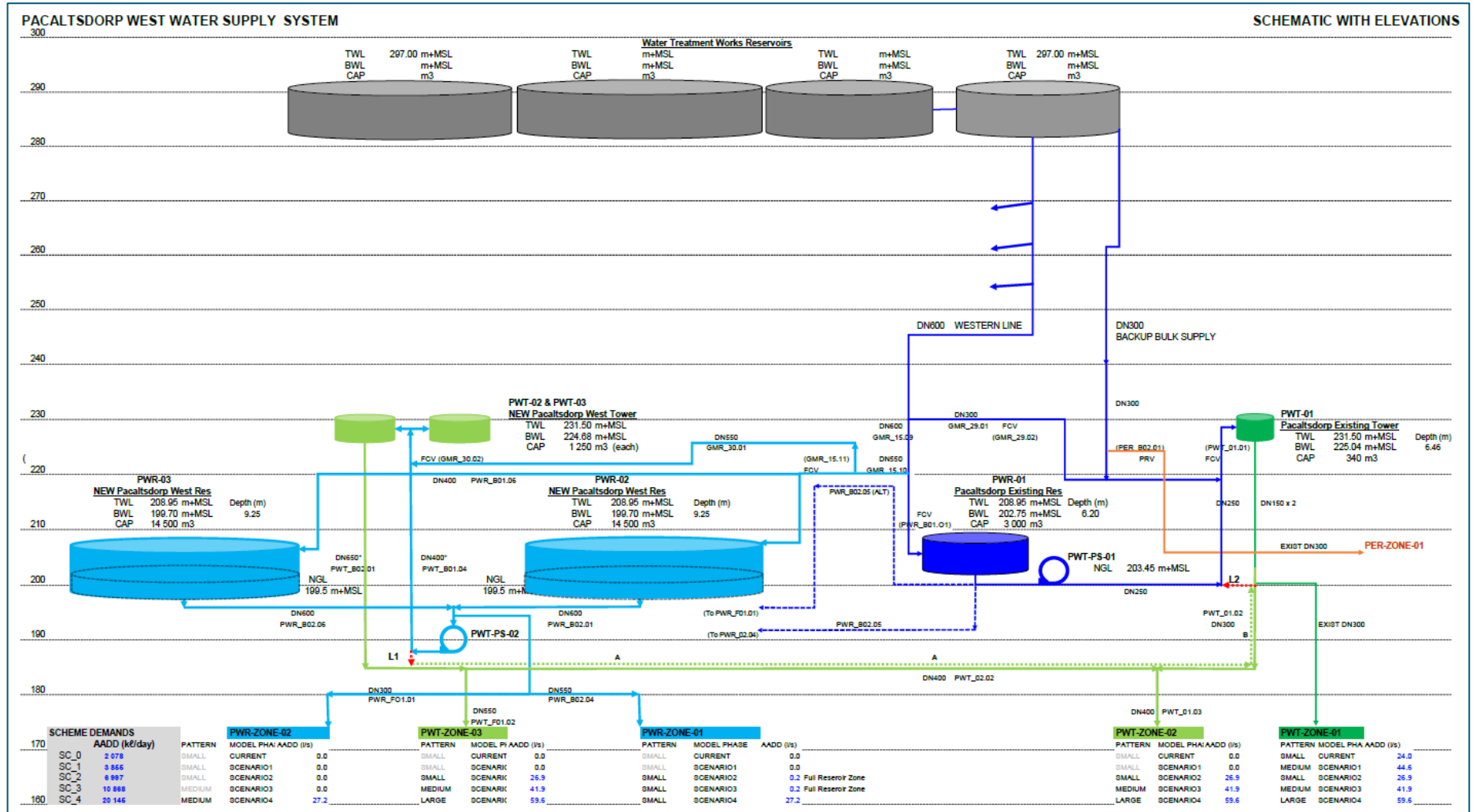

Figure 9: Schematic of Pacaltsdorp West water supply scheme

6.3 Hydraulic model

The system has been modelled hydraulically in EPANET with the existing/current situation presented in the initial model (Scenario 0), and with the new phases (Scenarios 1-4) taking into account the demands and demand patterns of the supply areas as they are developed and as they require more water.

The phases mentioned above are modelled in scenarios which each have runs (e.g. options) to simulate various flows and flow control options in the system.

Furthermore, and in addition to the hydraulic analysis, the effect of introducing a direct feed from the bulk supply system straight into the elevated tower(s) is modelled. The subsequent effect on water age/quality in the reservoirs, as well as the pumping energy used (or saved), is modelled and discussed.

6.3.1 George bulk water supply system

The following bulk supply and flow conditions are common to all of the scenarios in the hydraulic model:

- Bulk supply: The source supply is the reservoir complex at the Old WTW, with the water being transported by the bulk pipeline system through the town of George (as described in section 5.1), and finally by the DN600 GRP “Western line” which then reduces to a DN300 connection at the reservoir PWR-01 site.
- Note that the bulk system through George Town has been modelled simplistically to approximate the predicted future pressures at the Pacaltsdorp delivery end. The predicted future pressure/flow data in the bulk supply system, was obtained from GLS and GLM, and provides the inputs for the modelling of the incoming supply to the Pacaltsdorp West scheme (GLS & GLM, 2022).
- The DN600 (western line) bulk supply pipeline is to be extended with a new DN600 pipeline to supply the proposed new 14,5 Mℓ reservoir PWR-02 (and PWR-03) site, while continuing to supply the existing reservoir PWR-01 site via its DN300 connection.

6.3.2 Pacaltsdorp West system

The phases of the Pacaltsdorp West scheme, are described in **section 6.1** above, and are modelled in these phases to supply the demands as they increase over time.

The hydraulic model is set up to route the water from the bulk supply system directly to the towers, as well as through the reservoirs and via the pumpstations, to the elevated towers and finally to supply water to their respective zones.

Important points to note in the model:

- a) The existing tower PWT-01 can be fed directly, from the residual pressure in the bulk supply system - without the need to pump from the 3 Mℓ reservoir PWR-01. However, bypassing PWR-01 will result in the water age in the reservoir increasing and affecting its water quality (should the residual chlorine levels drop below acceptable levels).

In order to prevent the reservoir water to become stagnant (free chlorine residual becoming too low), a system is proposed whereby the flow rate to the reservoirs and the flow rate direct

to the tower will be controlled by flow control valves and whereby the flow rate to the tower will be restricted to a set rate which will, during each outflow condition, result in the tower water level dropping to bigger pump starts.

- b) The direct feed option described above also applies to the future PWT-02 tower and PWR-02 reservoir.
- c) The direct feed to the existing tower PWT-01 and future PWT-02 are modelled as different scenarios with increasing demands, and new phases implemented as they are required.
- d) The scenarios have been modelled for different flows in the direct feed to the tower/s, starting at zero direct feed flow Q as follows:
 - o Run A flow $Q=0$
 - o Run B flow $Q=0,5 \times \text{AADD}$
 - o Run C flow $Q=1,0 \times \text{AADD}$
 - o Run D flow $Q=\text{Full flow}$ (Full flow = GLS Masterplan FCV setting)
- e) Further Runs (E, F, G etc.) added as necessary.
- f) The direct feed connection/s to the tower/s can be used at any time as an emergency supply in case of loadshedding, power failure or when energy saving is prioritised over water quality.
- g) Flow control: Flow control valves (FCVs) are used to control the direct feed flows to the reservoir and the tower respectively. Further investigation will determine the need for refurbishment of the existing FCVs and/or the installation of new FCVs at the existing reservoir site. See Annexure F and Annexure G for the positions indicated in the GLS Masterplan.
- h) Pump control: Pump controls are modelled to start and stop the pumps on selected water levels in the destination tank/reservoir.

6.3.2.1 Scenario 0 (current)

In Scenario 0, the current demand situation is analysed. Initially, the first run (Run A) is set to model the system as it is operated at present – with all of the water being stored in the existing 3 ML reservoir PWR-01, and then being pumped to the tower PWT-01.

- Supply zone: At present, there is one supply zone, PWT-Zone-01, which is directly connected to the outflow pipelines from the tower.
- Demand pattern: The small area demand pattern was used to model this scenario. See Annexure H for the demand patterns data.
- AADD: The current AADD is 2 078 kl/day (from **section 4** and **Table 6**)

After the first run (Run A), the effect on the required pumping and flow rates for different direct feed flows, as described in **section 6.3.2** above, are modelled.

Table 11: Results summary Scenario 0

SIMULATION 10 DAYS (240 HRS)	UNIT	RUN A	RUN B	RUN C	RUN D
Direct feed to tower (flow)	l/s	0.0	12.05	24.10	39.00
Direct feed to tower (daily volume)	kl/day	0	1 039	1 661	2 084*
Pumped flow from reservoir (max)	l/s	60.0	48.0	35.9	0.0
Pumped flow daily volume	kl/day	2 071*	1 060	419	0
Water Age - Tower (Day 10)	hrs	86	80	69	49
Water Age - Reservoir (Day 10)	hrs	82	114	169	250
Pumping Cost per annum	R/a	165 024	97 847	47 263	0

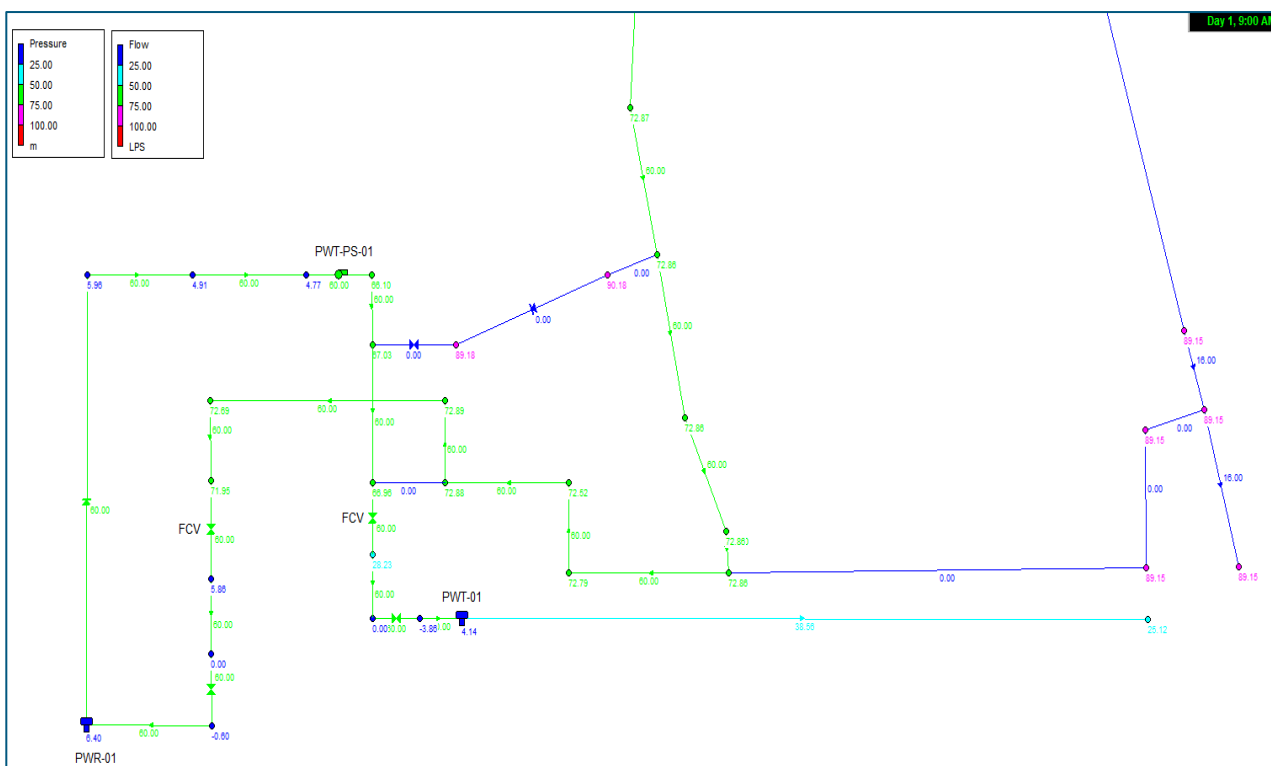

Figure 10: EPANET model of existing reservoir and tower site for Scenario 0

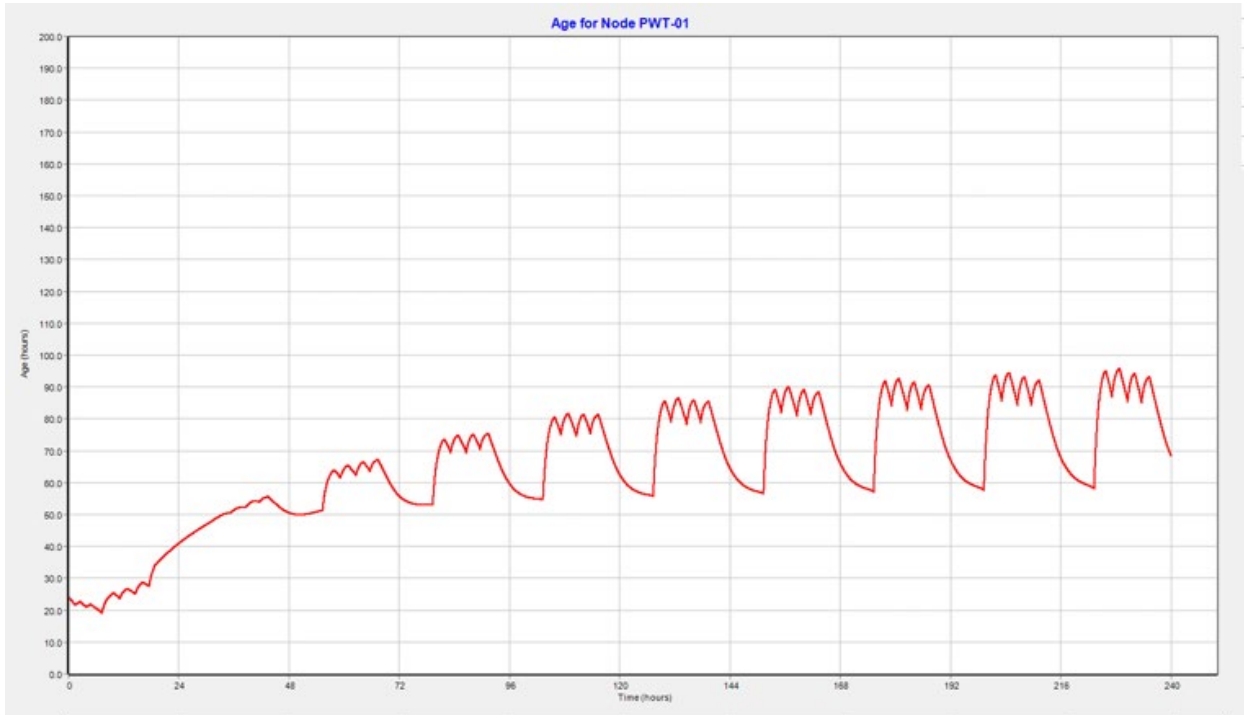

Figure 11: Water age graphic - tower PWT-01 (Scenario 0, Run B)

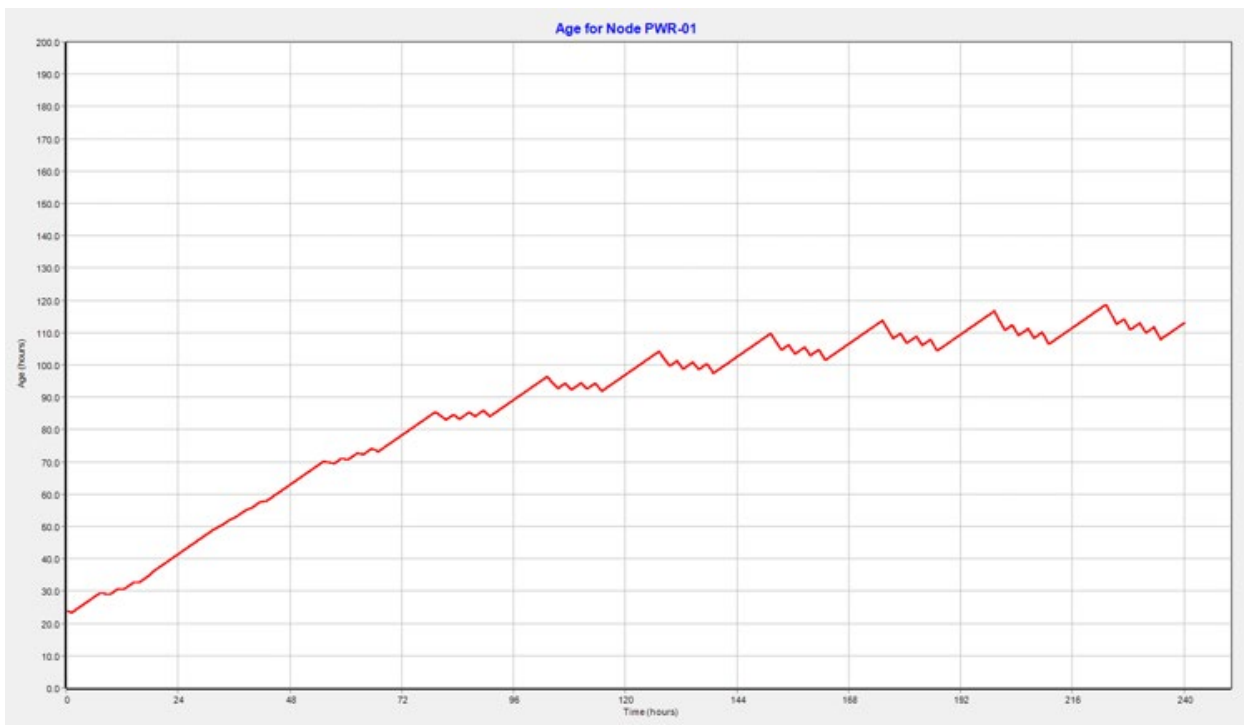

Figure 12: Water age graphic - reservoir PWR-01 (Scenario 0, Run B)

Results:

- Run A, all pumped to tower, no direct feed, the maximum water age is approximately 3,5 days, and the annual pumping cost (estimated at R1/kWh) is approximately R165 000 (R14 k/month).
- Run B, to achieve the target value for water age in the reservoir (approximately 4 days), the direct feed flow must be limited at the FCV to approximately 50% of AADD (12,05 l/s), resulting in an annual pumping cost of approximately R98 000 (R8 k/month).
- Run C, with the direct feed at 100% of AADD flow (24,1 l/s), the reservoir water age is 7 days, and the annual pumping cost is approximately R47 000 (R4 k/month).
- Run D, with the direct feed at the 160% of the AADD flow (39 l/s), the reservoir water age is more than 10 days, but no pumping is required.

6.3.2.2 Scenario 1 (5-year demand horizon)

In this scenario the five-year demand horizon is analysed, with the addition of the new 14,5 Ml reservoir PWR-02 and pumpstation PWT-PS-02 constructed at the new reservoir site. The figures below show the overall and an enlarged view of the pipework configuration that was modelled for **Scenario 1**.

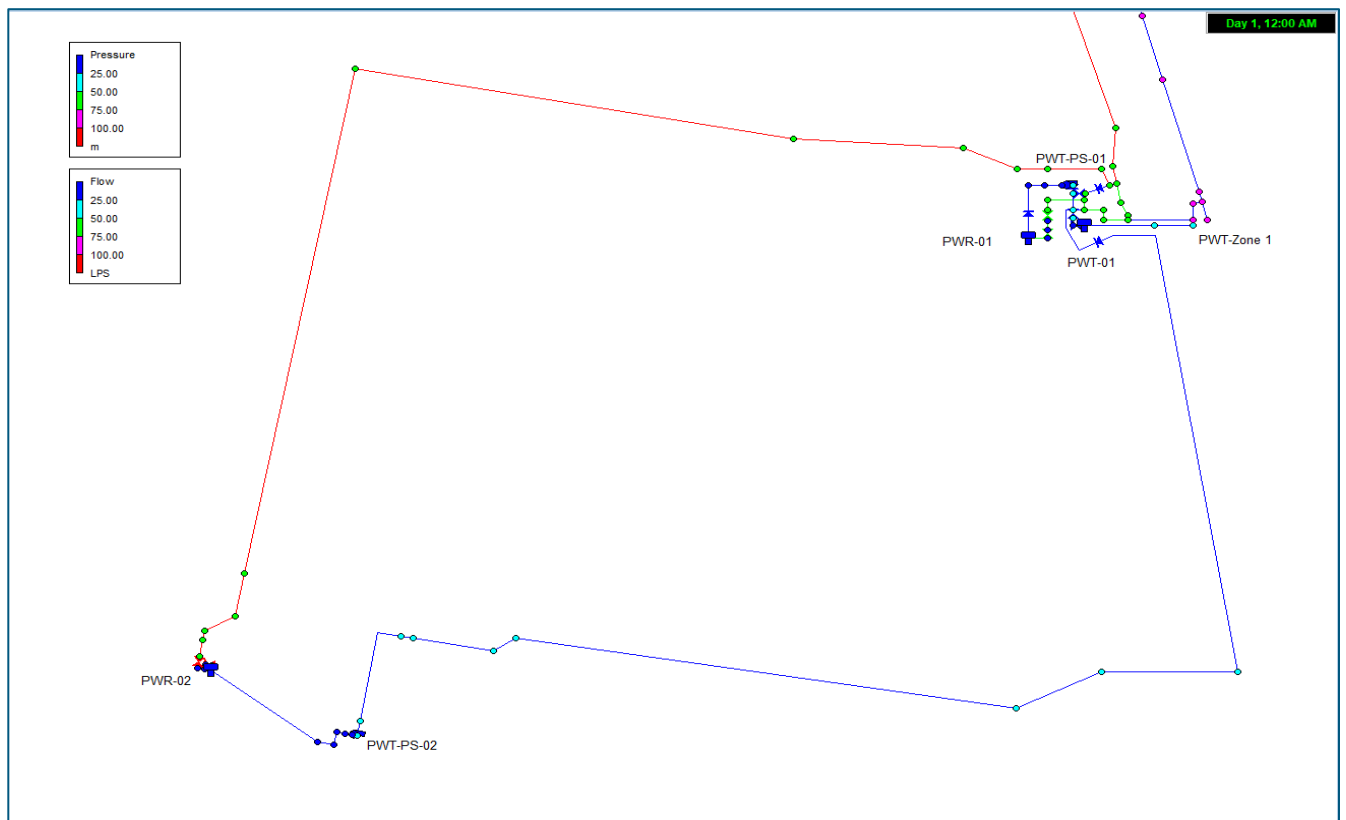

Figure 13: Scenario 1 (5-year demand horizon)

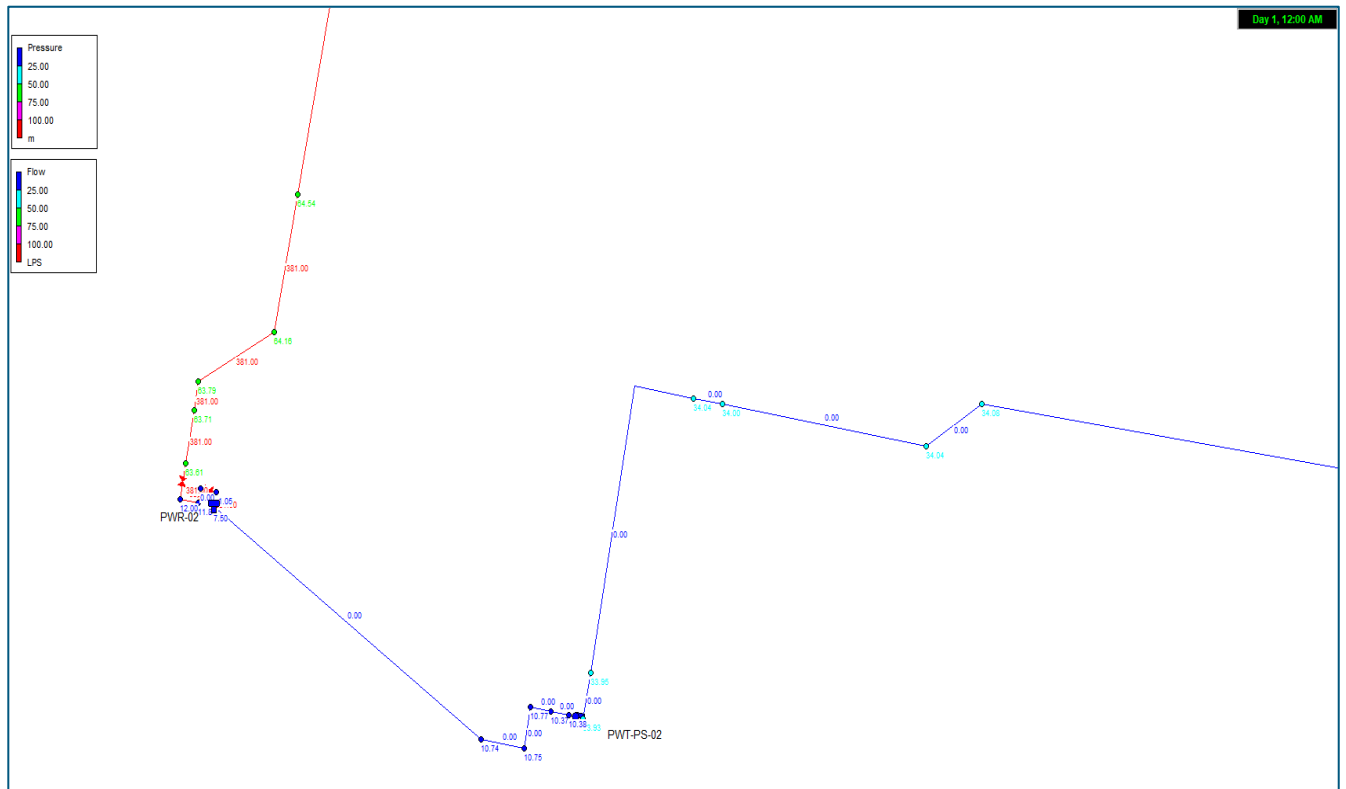

Figure 14: Scenario 1 New reservoirs' site

- Bulk supply: This phase (Phase 1A) implements the new 14,5 Ml ground reservoir PWR-02, which is fed by the extension of the DN600 (western line) pipeline. Then, from the reservoir PWR-02, water is pumped by the new pumpstation PWT-PS-02 to the existing PWT-01 tower.
- For this phase, the civil and building works for the new pumpstation PWT-PS-02 will be constructed to its full size. However, the mechanical and electrical equipment will be installed to accommodate the required water demand for this design horizon.
- Supply zone: PWT-Zone-01, (supplied from the tower PWT-01), as detailed under **section 6.1.1.2, Phase 1A, Scenario 1**.
- Demand pattern: The medium area demand pattern is used for this scenario. The supply area has increased.
- **AADD: The projected AADD is 3 855 kℓ/day for the Scenario 1 (5-year demand horizon).**

Table 12: Results summary Scenario 1

SIMULATION 10 DAYS (240 hrs)	UNIT	RUN A	RUN B	RUN C	RUN D
Direct feed to tower PWT-01 (flow)	ℓ/s	0.0	22.3	44.6	39.0
Direct feed to tower PWT-01 (volume)	kℓ/day	0.0	1 669	2 158	2 144
Pumped flow from reservoir (PWR-01)	ℓ/s	56.9	56.9	56.9	56.9
Pumped flow daily volume (PWR-01)	kℓ/day	1 461	859	633	639
Pumped flow from reservoir (PWR-02)	ℓ/s	93.1	93.1	93.1	93.1
Pumped flow daily volume (PWR-02)	kℓ/day	2 391	1 436	1 053	1 072
Water age - Tower PWT-01 (day 10)	hrs	107	76	64	62
Water age - Reservoir PWR-01 (day 10)	hrs	107	124	159	152
Water age - Reservoir PWR-02 (day 10)	hrs	114	149	177	173
Pumping cost per annum	R/a	316 997	183 768	125 336	130 263

Scenario 1 – Initial runs: Scenario 1 was modelled initially with the pumped flows divided evenly between the two pumpstations and therefore with the two reservoirs supplying similar daily volumes. However, this resulted in longer storage time for the new reservoir. Therefore, the adopted flow were such the new Pump station can do almost double the flow rate of pump station 2.

- Run A, all pumped to tower, no direct feed, the maximum water age is approximately 5 days at the PWR-02 and about 4,5 days at PWT-01, and the annual pumping cost for both pump stations (estimated at R1/kWh) is approximately R317 000 (R27 k/month).
- Run B, with a direct feed flow limited at the FCV to approximately 50% of AADD (22,3 ℓ/s) the maximum water age at PWR-02 is 6.2 days which is just under the 7-day preferred limit, and approximately 3 days at PWT-01 and 5 days at PWR-01. Resulting in an annual pumping cost of approximately R190 000 (R16 k/month) for both pump stations.
- Run C, with the direct feed at 100% of AADD flow (44,6 ℓ/s), the reservoir PWR-01 and PWR-02 water age is 6,6 days and 7.4 days respectively, and 2.5 days water age at PWT-01. the annual pumping cost is approximately R126 000 (R11 k/month) for both pump stations.
- Run D, with the direct feed at 39 ℓ/s as per the masterplan, the reservoir PWR-01 and PWR-02 water age is approximately 6 days and 7.2 days respectively, and 5 days water at PWT-01. the annual pumping cost is approximately R130 000 (R11 k/month) for both pump stations.

Note that with the direct feed flow in Run B and Run C, gives a maximum water age at PWR-02 of 7.2 and 7.4 days which exceeds the 7-day preferred limit.

Scenario 1 – Run B optimised:

Thus, we see that for **Scenario 1**, as for **Scenario 0**, the direct flow feed must be limited to a flow of approximately 50% of AADD (22,3 l/s) to maintain an acceptable water age in the reservoirs. In addition, the majority of the balance of the (non-direct feed) water must be routed through the new (larger) reservoir PWR-02, to result in an acceptable water age in the larger reservoir.

To control the amount of water pumped from each reservoir, the pump stop level (in the tower) is adjusted for each pumpstation. In this case, the PWT-PS-01 has a lower pump stop level setting, which results less water being pumped from PWR-01 (refer to **Figure 16**) than from PWR-02 (refer to **Figure 15**). This way, the pump duties are still alternated, and the required split can be achieved without introducing timers on the pump controls, as discussed.

This represents a preliminary optimised operation of the system for Phase 1 of the scheme.

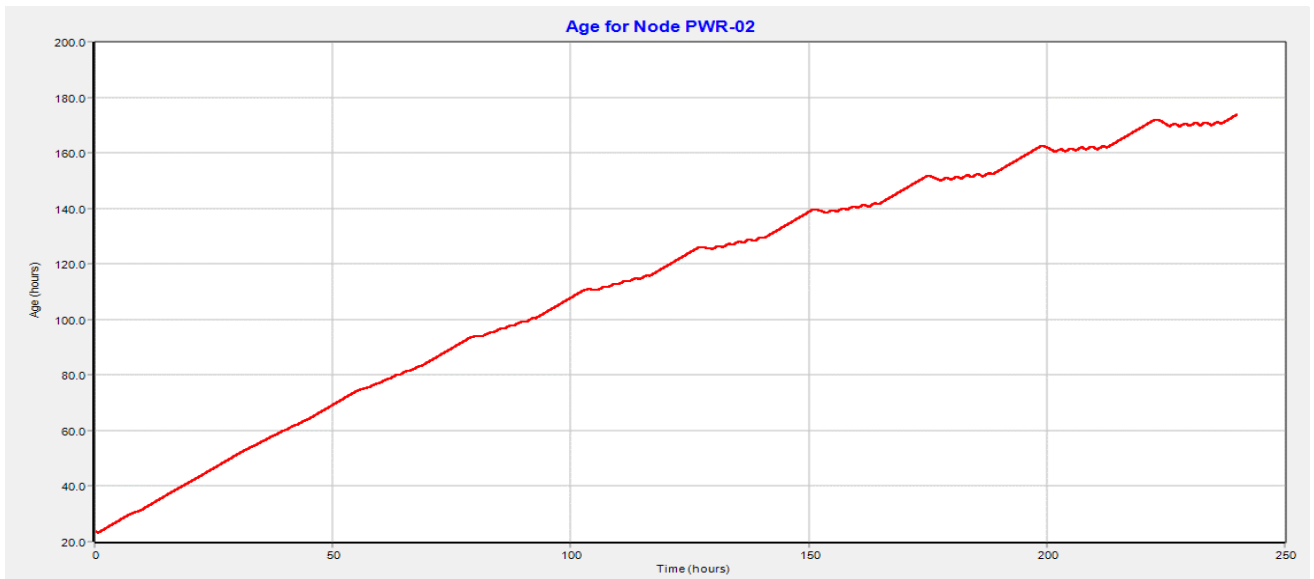

Figure 15: Water age graphic – reservoir PWR-02 (Scenario 1, Run B)

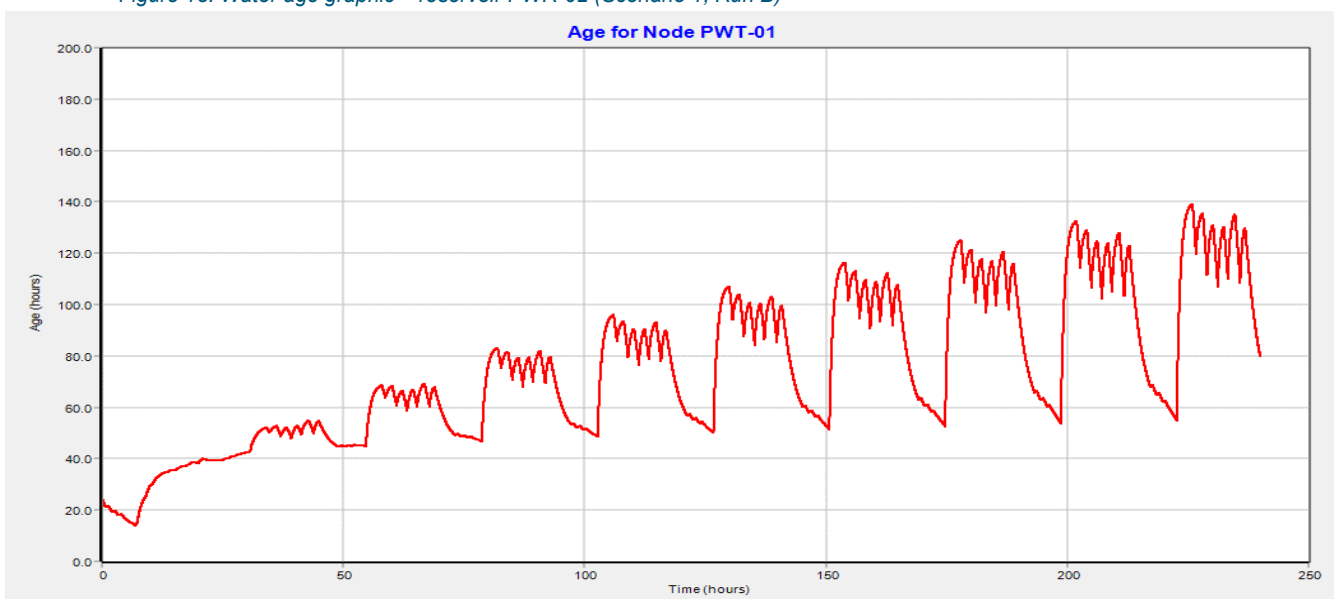

Figure 16: Water age graphic – tower PWT-01 (Scenario 1, Run B)

6.3.2.3 Scenario 2 (10-year demand horizon)

In this scenario, the ten-year demand horizon is analysed, with the addition of the new 1,25 Ml tower at the new reservoir site. The figures below show the overall and an enlarged view of the pipework configuration that was modelled for **Scenario 2**.

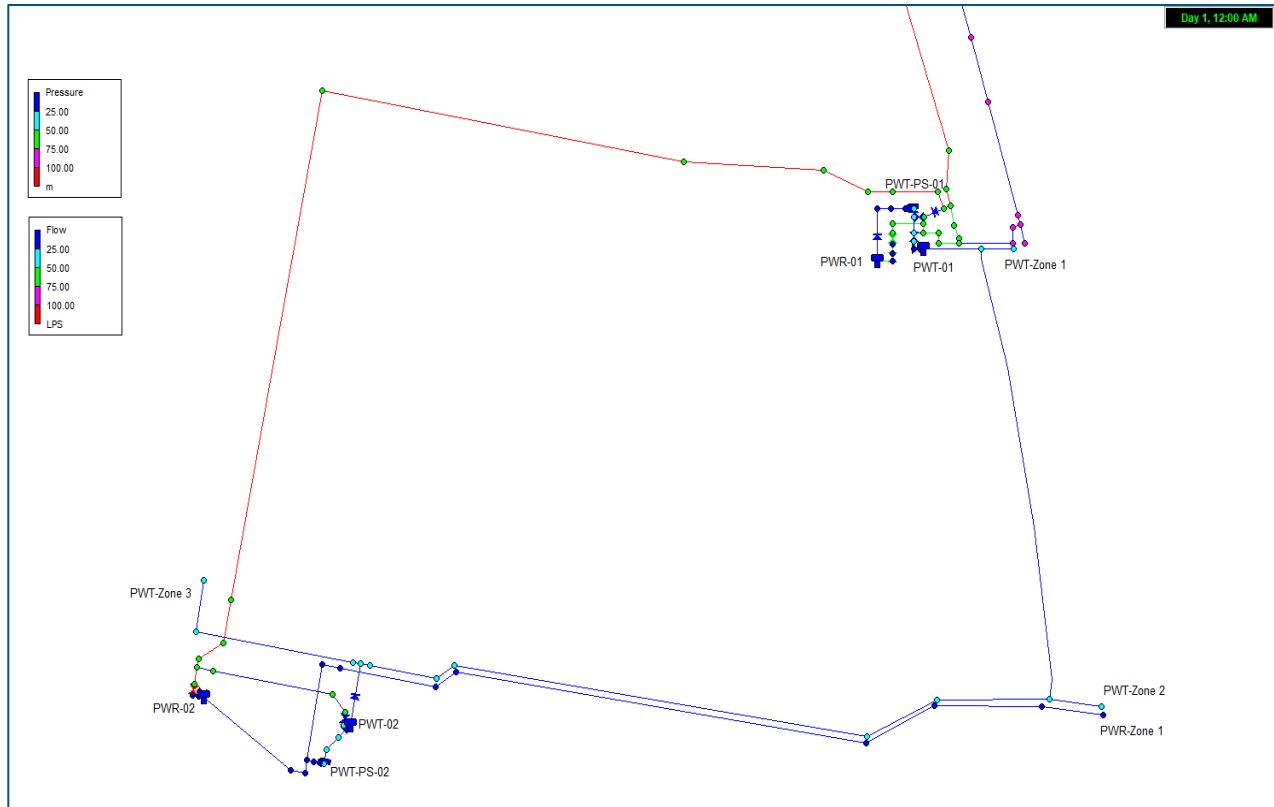

Figure 17: Scenario 2 (10-year demand horizon)

- **Bulk supply:** This phase (Phase 1B) adds the construction of a new 1,25 Ml tower PWT-01 which is fed through PWT-PS-02 with PWR-02 as the suction reservoir. Note that the outgoing gravity pipelines from the reservoir site to the reservoir zones, can be delayed to Phase 2, to suit the planning progress as those future areas are developed.
- For this phase, the mechanical and electrical equipment at the new pumpstation PWT-PS-02, will be upgraded to meet the supply requirements to PWT-02. The pipelines that served as the pumping main from PWT-PS-02 to PWT-01, will be restored to their ultimate purpose, as gravity feed lines to the tower zones.
- **Supply zone:** At this stage, the bulk of the overall supply zone is still fed by the towers. The tower zone is split into three separate zones, which are interconnected, but can also be fed from each of the towers. The reservoir zone PWR Zone 1, does not have any significant demands in this scenario.
- **Demand pattern:** The small area demand pattern was used at each demand nodes for the tower zones. Though the area of supply has increased, the split into the three different zones has made each zone smaller hence the small area pattern (i.e. more conservative peak factors than for a large zone). For the reservoir zone, the small area demand pattern was also used.

- **AADD: The projected AADD is 6 976 kℓ/day for the Scenario 2 (10-year demand horizon).**

Table 13: Results summary Scenario 2

SIMULATION 10 DAYS (240 hrs)	UNIT	RUN A	RUN B	RUN C	RUN D
Direct feed to tower PWT-01 (flow)	l/s	0,0	13,5	26,9	39,0
Direct feed to tower PWT-01 (daily volume)	kl/day	0	936	1 921	3 083
Direct feed to tower PWT-02 (flow)	l/s	0,0	13,5	26,9	381,0
Direct feed to tower PWT-02 (daily volume)	kl/day	0	1 113	1 334	3 696
Pumped flow from reservoir (PWR-01)	l/s	60.0	60.0	60.0	0.0
Pumped flow daily volume (PWR-01)	kl/day	3 951	3 044	2 166	0
Pumped flow from reservoir (PWR-02)	l/s	146.3	146.3	146.3	0.0
Pumped flow daily volume (PWR-02)	kl/day	3 014	1 865	1 552	0
Water Age - Tower PWT-01 (Day 10)	hrs	56	57	61	40
Water Age - Tower PWT-02 (Day 10)	hrs	147	140	141	47
Water Age - Reservoir PWR-01 (Day 10)	hrs	54	62	76	262
Water Age - Reservoir PWR-02 (Day 10)	hrs	140	170	180	260
Pumping Cost per annum	R/a	396 760	319 554	261 431	0

- Run A, all pumped to tower, no direct feed, the maximum water age is approximately 6 days at the PWR-02. The annual pumping cost for both Pump stations (estimated at R1/kWh) is approximately R397 000 (R17 k/month).
- Run B, with a direct feed flow limited at the FCV to approximately 50% of AADD (13,5 ℓ/s) the maximum water age at PWR-02 is 7 days, and approximately 2,5 days at PWT-01 and PWR-01. Resulting in an annual pumping cost of approximately R320 000 (R13,5 k/month) for both pump stations.
- Run C, with the direct feed at 100% of AADD flow (26,9 ℓ/s), the reservoir PWR-01 and PWR-02 water age is 3 days and 7,5 days respectively and 2,5 days water at PWT-01. The annual pumping cost for both pump station is approximately R261 000 (R22 k/month).
- Run D, with the direct feed to PWT-01 and PWT-02 at 39 ℓ/s and 381 respectively as specified by the GLS Masterplan, the reservoir PWR-01 and PWR-02 water age is approximately 11 days, and about 2 days for both towers. This option resulted in no pumping as the direct feed supply more than the required demand flow.

6.3.2.4 Scenario 3 and Scenario 4

Scenario 3 consists of the construction of the second 14,5 Mℓ reservoir PWR-03 and the upgrade of PWT-PS-02 pump station to accommodate the increase in water demand for the 25-year design horizon.

Scenario 4 consists of the construction of a second 1,25 Mℓ tower PWT-03 to increase the elevated storage time to 4 hours of AADD. This is the ultimate scenario.

Figure 18 shows snip of the layout of the proposed infrastructure at the new reservoirs site.

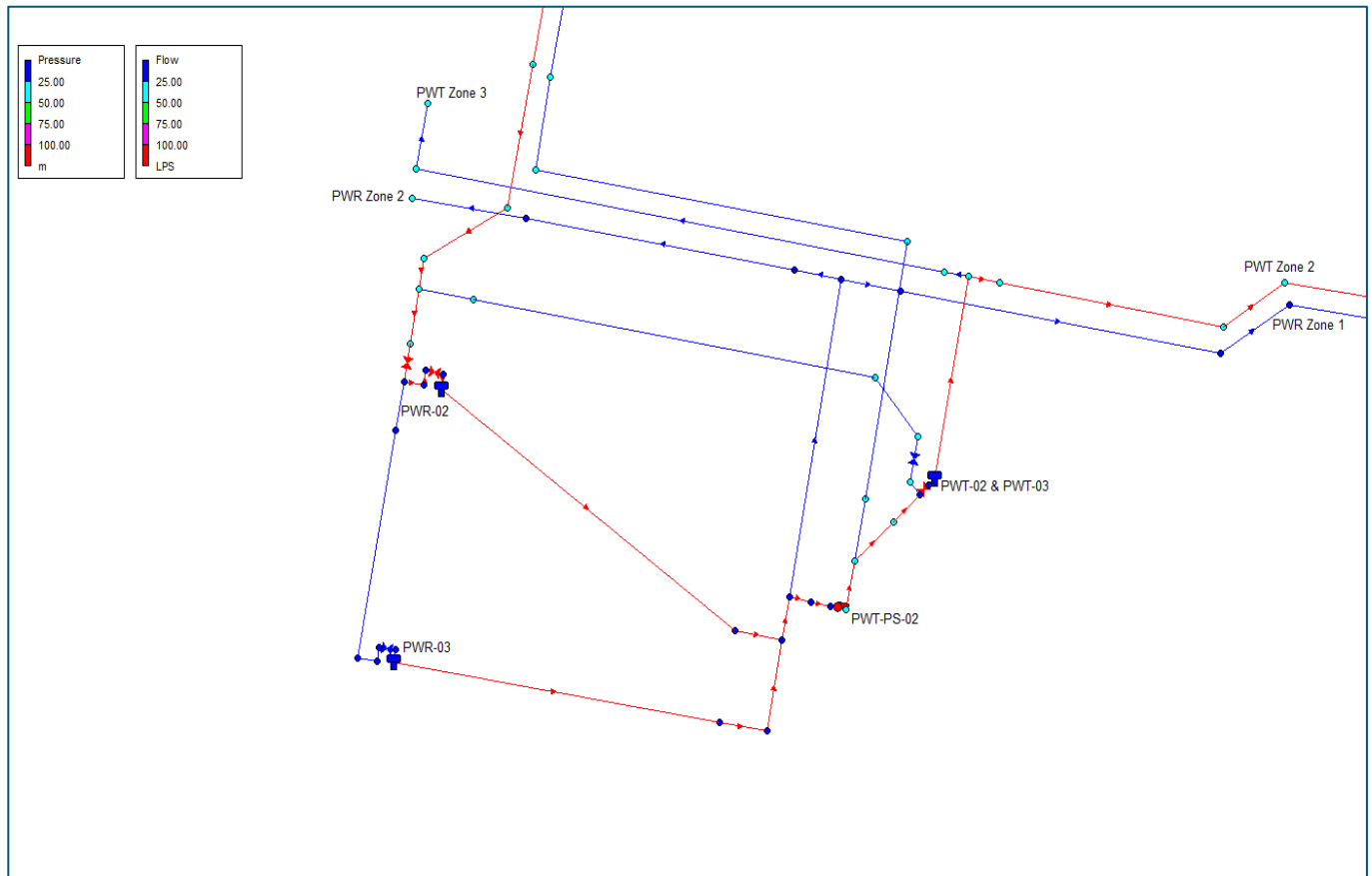

Figure 18: Scenario 4 New Reservoir site

- This scenario analyses the 25-to-50-year demand horizon. Refer to Scenario 3 and 4 above.
- Supply zone: Three different tower zones and two reservoir zones. As per the GLS Masterplan. All zones are interlinked and can be fed from the different towers. However, PWT Zone 01 and 02 are likely to be supply mainly by PWT-01 and PWT-02 combine, whereas PWT Zone 3 will be supplied by PWT-02 only.

PWR Zone 1 and Zone 2 are supplied directly from the ground reservoir.

- Demand pattern: The large area demand pattern was used at each demand nodes for the tower zones as the supply zone has increased, and for the reservoir zone it is the medium area demand pattern that is used of the flow calculation.

6.3.3 Water age

The water age was modelled on EPANET 2.2, for a period of ten days. However, a one-day water wage was included as an initial condition for both reservoirs and the tower.

The result shown in the **Figure 19** below is for the Phase 1A scenario 1. There are four different runs for this scenario as shown in **Table 12**. Run B results are discussed below, this run includes pumping and direct feed combination.

Figure 19 shows the results of the network without the introduction of a timer to alternate between the two pump stations but the on and off switch is dependent on the water level in tower PWT-01.

The results shows that water in the pumping main from PWT-PS-02 pump station to PWT-01 tower get to about 7.4 days old whereas the maximum in the rest of the network is below 5 days.

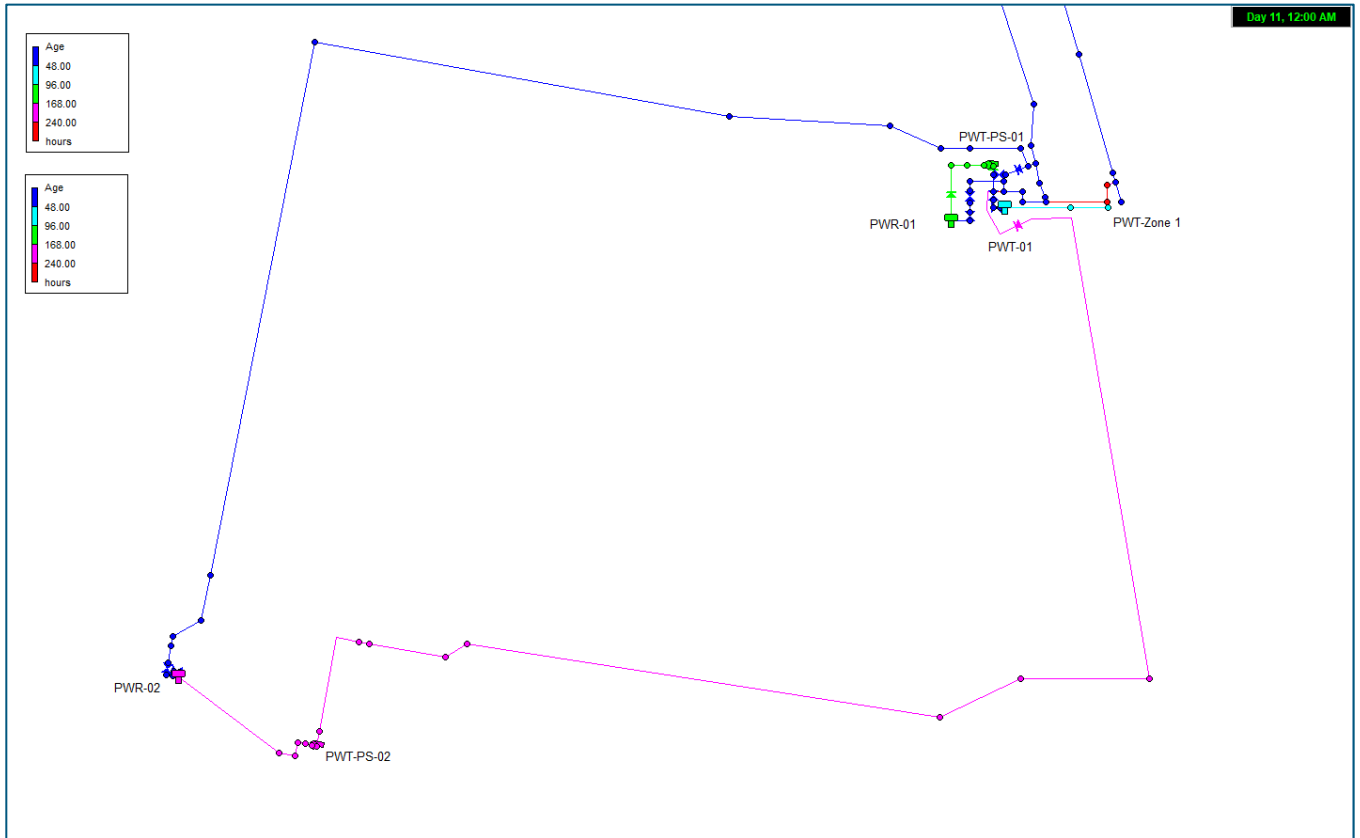

Figure 19 Phase 1 Scenario 1 Water age

It is to note that operating the reservoir PWR-02 at its full 8 m depth also affect the water age results. Therefore, for a reduced operation height of reservoir PWR-02 to approximately 50% full (4 m water depth), will provide sufficient storage for this current phase, as well as limit the water age to 7 days for the entire network.

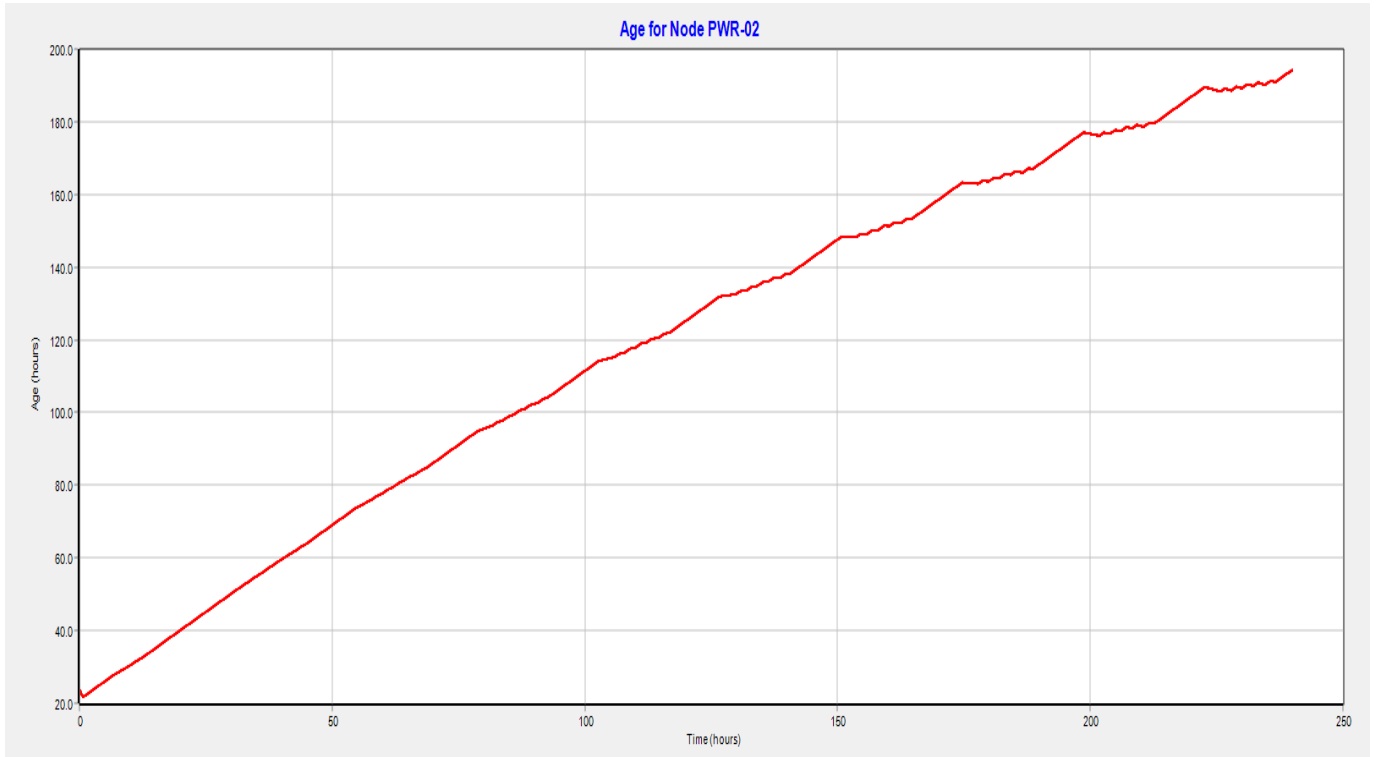

Figure 20: PWR-02 Water age, PWR-02 Operating at full capacity

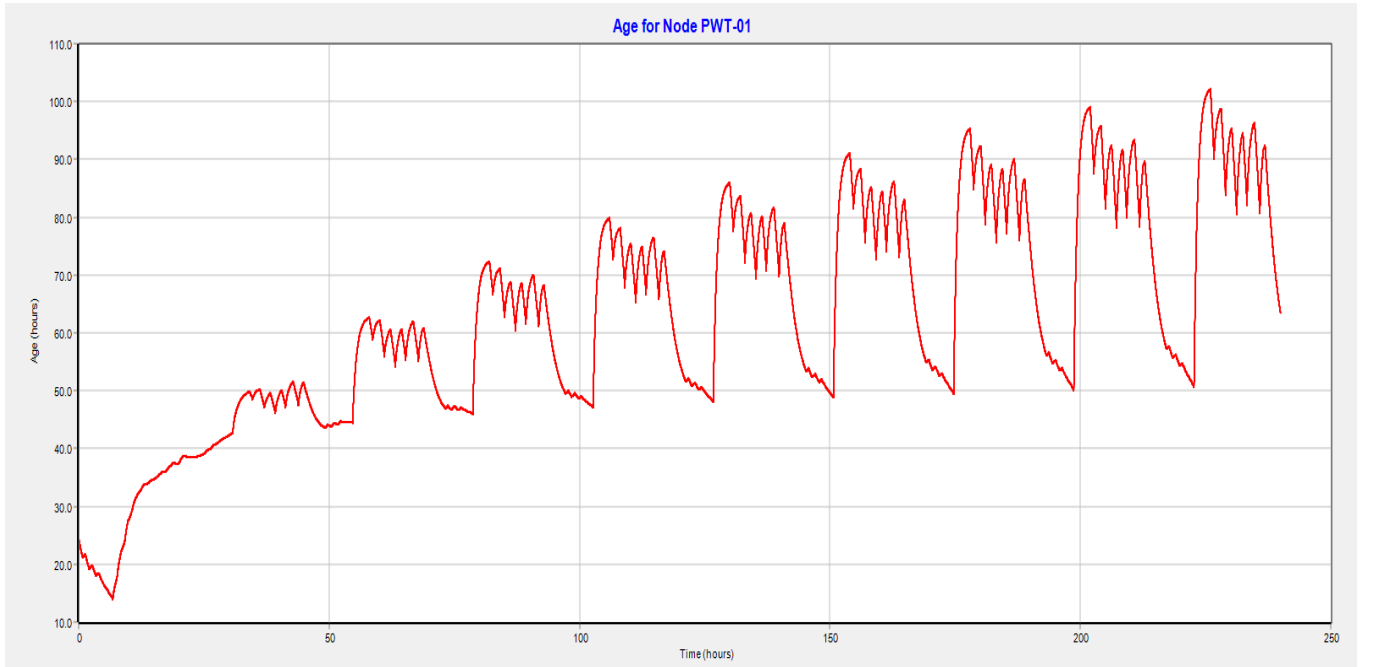

Figure 21: PWT-01 Water age

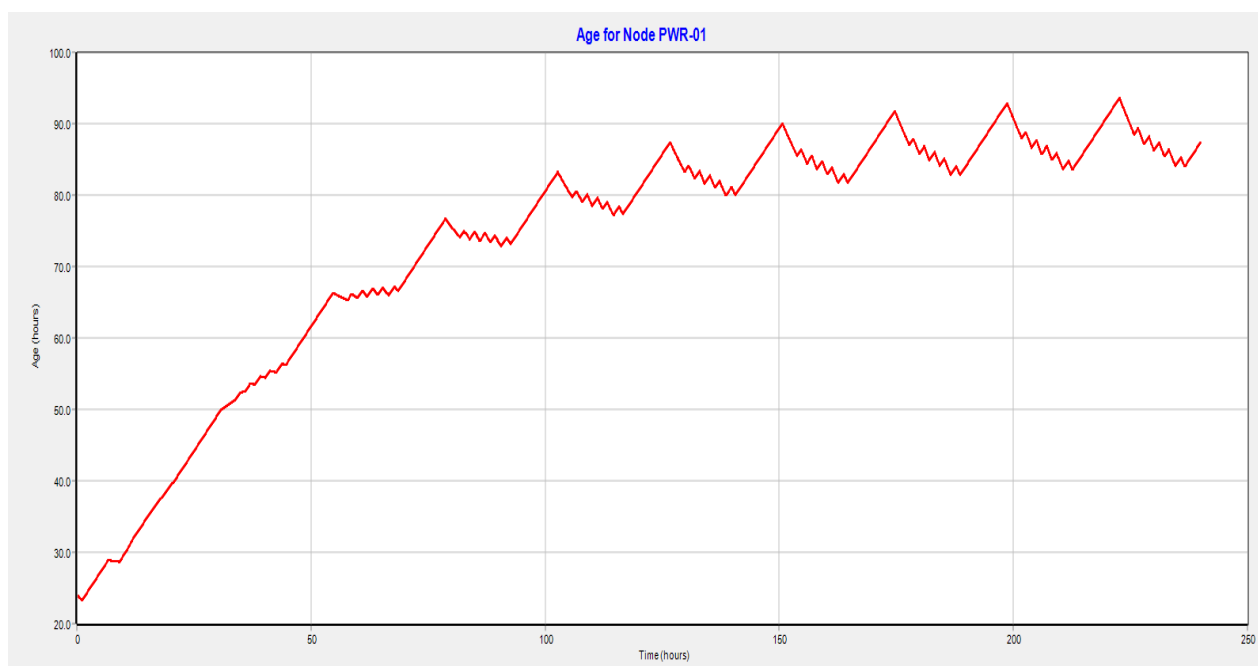

Figure 22: PWR-01 Water age

Figure 21 and Figure 22 shows the water age for PWT-01 and PWR-01 respectively. It can be seen that at the maximum age is approximately 5 days for both (PWR-01 and PWT-01), which is below the 7 days maximum.

Phase 1 - in summary, using water age as a proxy for water quality, the implementation of phase 1, as modelled in scenario 1, is shown to be feasible with the constraint of limiting the water age in the system to 7 days for the phase 1 total demand.

To reduce further on the water age, the flow control for the direct feed can be adjusted to supply a little less than 50% of AADD.

6.4 Recommendation for Preliminary Design

The design flow rates from the two pump stations needs to consider the 5 and 10-years demand scenarios which is Phase 1A and Phase 1B.

6.4.1 Phase 1A:

The existing Pump Station (PWT-PS-01) will continue to pump according to its curve (duty point) and will pump a flow rate of approximately 50l/s when PWT-PS-02 is pumping simultaneously. The New Pump Station (PWT-PS-02) at Peak time will pump an additional flow of 100 l/s, which will make a total of 150 l/s being pump to the Existing Tower (PWT-01). It (PWT-PS-02) will have two pumps (one duty and one standby).

See **Table 12** under **section 6.1.1.2**

These flow rates are considered both pumps (existing and New) pumping simultaneously. However, when working individually, the New Pumps need to be able to pump the full 150l/s to the existing Tower. This is to be able to deal with the Peak demand of approximately 156.1 l/s

It is to note that at this high flow rate the feeder/inlet pipe to the reservoir will have a velocity exceeding 3m/s during the peak time.

6.4.2 For Phase 1B:

This will see the construction of a New Tower (PWT-02) as the Existing Tower will not have storage capacity for the increase in demand and will need a bigger appropriately sized inlet pipe to the tower. Therefore, the design must allow for the following:

- The TWL's of the two towers (PWT-01 and the new PWT-02) are to be the same, and both supply all sub-zones of the overall PWT zone.
- Existing Pump Station (PWT-PS-01) will continue to pump as usual to PWT-01 (existing) and no additional flow will be needed as the New supply zones will now be connected to the new Tower (PWT-02).
- The New Pump Station (PWT-PS-02) needs to be upgraded with a third Pump of the same capacity as the one in Phase 1A, and in total will be able to pump approximately 300 l/s to the new Tower. This is to deal with the Peak demand flow rate of approximately 250 l/s (10 years demand scenario).

Therefore, the following needs to be allowed for the design of the pump station at Phase 1A:

Note: The design of the Pump stations (PWT-PS-02 and the future PWT-PS-03) is made separate from the direct feeds to the tower that can be achieved in both Phase 1A and 1B. I.e. PWT-PS-02 is designed to function as part of a complete bulk supply, reservoir (PWR-02), pumpstation (PWT-PS-02) and elevated tower (PWT-02) system. When there is direct feed to the Towers, Flow control valves with the flow set low enough, are used to limit the flow, and to prevent the water getting too old in both reservoirs. See water age scenarios which were analysed under **section 6.3.3**

7 Option analysis for reservoir shape and top water level

This section briefly analyses the options for the shape of the proposed new ground based reservoir (i.e. circular vs rectangular) and reviews the requirements and options for the reservoir top water level.

The conclusions from this section, i.e. the shape and top water level of the reservoir, will be applied as design criteria in the preliminary design detail section of this report.

7.1 Shape of ground-based reservoir

The shape of the 2 new ground-based reservoirs PWR-02 and PWR-03 was originally planned as rectangular – with cantilever walls and an enclosed roof (refer to the Feasibility and Concept & Viability Reports). The rectangular shape initially provided the most advantageous layout and most economical use of the space available on the originally proposed site, which had rectangular boundary lines.

7.1.1 Impact of preferred site

The selected and preferred site (previously referred to as Option B), makes the choice of a circular reservoir equally good in the available space. This site is even less sensitive to the positioning of the reservoirs on the site, which now does not have perpendicular boundary lines due to the adjoining wetland delineation.

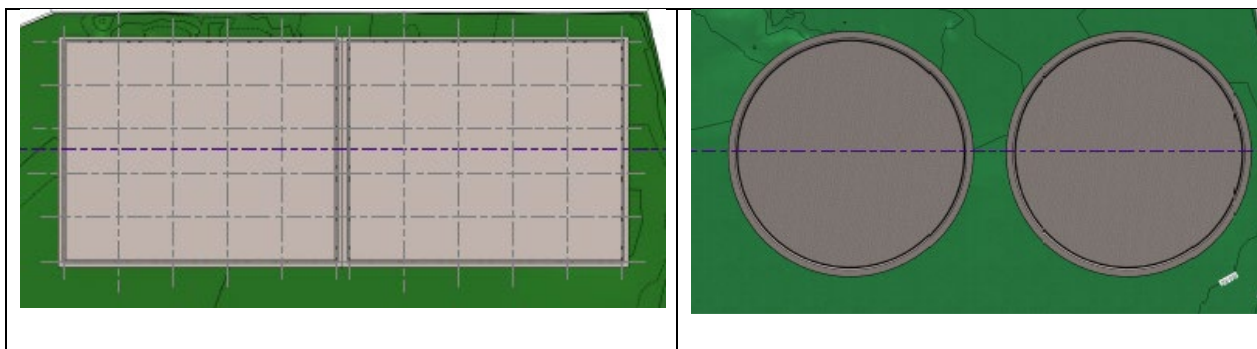

Figure 23: Indicative plan views for 2 x rectangular vs 2 x circular reservoir

For this preferred site, a circular concrete reservoir, with an enclosed roof, also provides an acceptable solution and can be optimised for space by making it deeper. At depths in excess of 8,0 m the circular reservoir design is more economical and constructable.

7.1.2 Maintenance considerations

A circular reservoir without a dividing wall cannot supply water during reservoir maintenance or repair. However, the extra wall comes with the added cost of the wall and additional inlet and outlet arrangements (chambers and pipework).

7.1.3 Topographical considerations

Whilst the circular and square shapes require the least land area, the rectangular shape can be better adjusted to suit the constraints of a constricted site, or to limit the across-slope excavation on a steeply sloped site.

Note that both these factors are not considerations on this site for the proposed new PWR-02 and PWR-03 reservoirs, as the site is relatively flat and the space constraints are not limiting the layout.

7.1.4 Cost considerations

Table 14 below lists the proposed size parameters for both circular and rectangular reservoirs that provide the required volume.

Table 14: Reservoir size parameters for 14,5 Ml storage capacity

Reservoir parameters	Unit	Rectangular 1	Rectangular 2	Circular
Full supply capacity	Ml	14,5	14,5	14,5
Inside length/diameter	m	49	51	45
Inside width	m	37	34	-
Area	m ²	1 813	1 734	1 590
Water depth	m	8,0	8,5	9,25

A comparison of the costs of structural concrete (concrete, formwork and reinforcement) and excavation, on large concrete reservoirs up to 8,5 m deep, was carried out. The comparison highlights the following:

- The volume of concrete as well as land area required for one large reservoir of any given capacity is lower than for two smaller reservoirs that make up that same capacity.
- The concrete costs for one large circular reservoir is the lowest of all options, followed by rectangular and then square. This is due to the smaller total wall area required for the same volume.
- The area required for one large circular reservoir is the lowest of all the options, followed by a singular square and then a rectangular shape.

The comparison showed that one large reservoir is more cost and land-use effective. It also centralises construction and operation (e.g. shared inlet and outlet chambers).

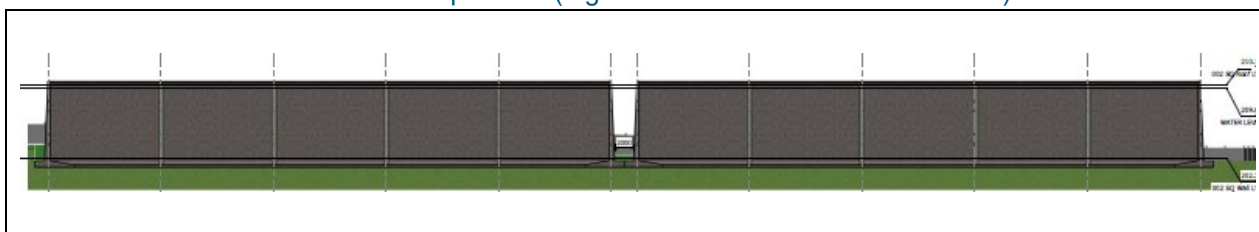
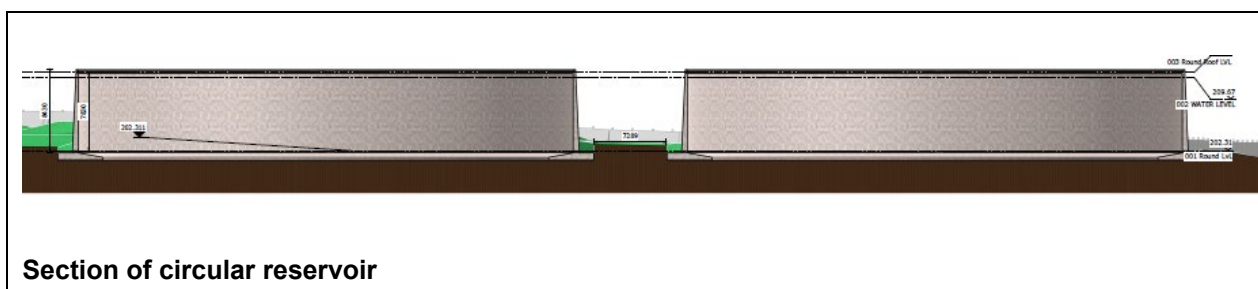

Figure 24: Typical section for 2 x rectangular reservoirs



Section of circular reservoir

Figure 25: Typical section for 2 x circular reservoirs

7.1.5 Summary

In summary, the comparison indicates that the cost saving of a circular reservoir can be up to 10% (less costly) than a square or rectangular reservoir with respect to the structural concrete cost. This represents an estimated difference in cost of approximately R2,5m between the circular and rectangular options.

Furthermore, as mentioned above, at depths in excess of 8.0 m, the circular reservoir design is more economical and constructable. This has further advantages in allowing the top water levels of the existing and new reservoirs to be matched without additional structural fill earthworks for the reservoir foundation, as discussed in the following sections.

The benefits of other designs and/or reservoir construction methods can be considered if offered by specialist tenderers (e.g. post-tensioning). However, the design responsibility would require to be allocated accordingly, and this route is not preferred or recommended.

The finding of this option analysis is that a circular reservoir will be viable on the selected site. As such, the preliminary design should proceed with a conventional circular reinforced concrete reservoir structure for the new 14,5 Ml reservoir. This choice has been confirmed as having been accepted by the George Municipality and is reflected in the preliminary design detail in this report.

7.2 Top water level co-ordination

7.2.1 TWL of existing reservoir

The TWL of the existing reservoir is 208,95 mMSL. One of the key considerations been to ideally match the top water level with that of the existing reservoir, if at all possible.

7.2.2 Site selection and natural ground level

The new reservoir site was selected on the basis of the criteria discussed above and in previous reporting. The natural ground level at the proposed new reservoir site is approximately 4,0 m below the ground level at the existing reservoir PWR-01. On the basis of this difference in ground level, some consideration would need to be given to the required top water level (TWL) and on that basis also to the reservoir foundation (depth and final level) and the reservoir geometry (depth).

7.2.3 TWL options

Consideration was given to whether to have the new reservoir at the same TWL or not and this was taken as a variable for an optimised and cost-effective design.

Given the difference in NGL between the existing and new reservoir sites, one of the impacts to be considered will be the depth of the engineered fill layer that will be required for founding the reservoir. Assuming the top water level of the existing reservoir must be matched, it would be necessary to either engineer a deeper reservoir (i.e. greater water depth) or a deeper fill (foundation) layer.

The cost of the fill layer is estimated (for comparative purposes) to be approximately R1,75m per metre of fill depth. As indicated in **Error! Reference source not found.**, the fill layer depth will be 0,510 m deep if the reservoir TWL does not need to match the existing, while it will be approximately 2,030 m deep if the TWL must match the existing.

- if the TWL is not matched and for a water depth of 8 m, approximately 0,50 m of engineered fill is required at a cost of R1,75m per meter implying a cost of $0,5 \times R1,75 \text{ m} = R0,88\text{m}$

- if the TWL is matched and for a water depth of 8 m, approximately 2,03 m of engineered fill is required at a cost of R1,75m per meter implying a cost of 2,02 x R1,75 m = R3,55m
- the difference between the 2,03 m and 0,50 m deep fill layers is (R3,55m – R0,88m =) R2,68m.

On this basis, the cost implication of matching the TWL and retaining a water depth of 8 m will be approximately R2,68m.

As was noted previously in this report, it would be possible to increase the water depth for the circular reservoir without major structural and cost implications. As such it would be possible to increase the water depth in order to match the TWLs. This would mean that the water depth might be increased (and the plan dimensions of the reservoir decreased accordingly) in order to reduce the depth of the engineered fill layer. With this increased depth the founding level of the new reservoir would be approximately at NGL.

Table 15 also considers the required depth of the engineered fill layer in the event of an increased water depth, in this case increased to 9,25 m. In this configuration, the circular reservoir terrace level is 0,22 m below NGL. By comparison, a circular reservoir with an 8 m water depth would be founded 1,03 m above NGL.

For the circular 9,25 m deep reservoir option, an engineered fill of 0,510 m (510 mm) would be required. The comparative cost of this layer would be R1.37m and the cost of achieving the matched TWLs would be R0,47m.

Table 15: Comparison of reservoir levels, water depth and TWL

Description and measurement unit	Ex. Res.	Proposed res. PWR-02		
	PWR-01	Match TWL, D = 8m	Different TWL D = 8m	Match TWL, D = 9.25m
TWL: Top water level (m msl)	208.950	208.950	207.430	208.950
D: Reservoir depth (m)	6.200	8.000	8.000	9.250
BWL: Bottom (low ^a) water level (m msl)	202.750	200.950	199.430	199.700
FFL: Finished floor level ^b (m msl)		200.850	199.330	199.600
Terrace Level ^c (m msl)		200.530	199.010	199.280
NGL (m msl)		199.500	199.500	199.500
Terrace level - NGL (m)		1.030	-0.490	-0.220
Excavation depth to founding ^d level m		1.000	1.000	1.000
Founding ^d level (m msl)		198.500	198.500	198.500
Depth of engineered fill ^e (m)		2.030	0.510	0.780
Rate for engineered fill (R millions/metre depth)		R1.75m	R1.75m	R1.75m
Cost of engineered fill (R millions)		R3.56m	R0.90m	R1.37m

7.2.4 Summary

The advantage of matching the top water levels is that the two reservoirs could be operated to supply the same zone directly without overflowing either reservoir, and without installing additional check valves (non-return valves) and control systems.

At present, the existing PWR-01 reservoir is only used to supply the tower PWT-01 (and hence the PWT zone). Given the function of the reservoir, there is at present no pressing need to match the TWLs.

If the existing PWR-01 reservoir's outlet pipework were to be connected to the future PWR reservoir zone, as indicated in the masterplan, it will be advantageous to make the TWL's the same for both reservoirs

It will be advantageous to make the TWL's the same for both reservoirs. The result will be that connection between the existing and new reservoirs will be as reflected in the GM water master plan.

7.3 Conclusions

Reservoir top water levels

The preliminary design is to be based on the new reservoir PWR-02's TWL being matched to the TWL of the existing PWR-01 reservoir.

- The TWL of the new PWR-02 must be reflected in the design criteria as 208,950 m (amsl);
- The TWL of the existing reservoir must be verified by topographic survey. (The setting out bench-mark level for the proposed reservoir will be correlated by precise level survey (1 mm tolerance) of the overflow levels of the existing Pacaltsdorp reservoir and water tower.)

The details of the proposed foundation levels, engineered fill and other geotechnical and structural issues are discussed in section 8 of this report.

Reservoir shape:

A conventional circular reinforced concrete reservoir offers both cost and structural benefits, and is thus recommended as the preferred option. The circular reservoir with an increased water depth also offers the further benefits of matching the reservoir zone water levels, and saving the costs of extra structural fill earthworks to achieve this.

- The shape of new PWR-02 must be reflected in the design criteria as circular.
- Given the context of the preceding discussions (i.e. as they relate to reinforced concrete) the material of construction must likewise be reflected as reinforced concrete.

8 Preliminary design details for proposed infrastructure

8.1 Overview

This section provides (and summarises) the design criteria for, and describes the infrastructure that is planned to be implemented under, **Phase 1A** of the overall project. This consists of:

- A new 14.5 Ml reservoir (PWR-02)
- A new pump station (PWP-02)
- Inter-connecting pipework between the old reservoir and the new

NOTE: The sizes and dimensions in this document, both in the text and the images, are preliminary and subject to revision in the detail design process. The sizes and dimensions are provided only in order to describe, in broad outlines, the concept that is intended to be further developed in the detail design stage and for which approval is thus being sought by way of this Preliminary Design Report.

8.1.1 Site selection

The proposed new reservoir, tower and pumpstation site was chosen to use the most suitable available site, at an elevation that was practical (high enough), and that could also comply with criteria required by town planning, environmental and public interest requirements.

Following the town planner's and environmental consultant's recommendations, the site was selected and has been approved and adopted for this preliminary design. Refer to the previous reports – Inception, Feasibility, Concept & Viability - and the inputs from the town planning team.

Once the position of the reservoir site was selected, and the pipeline routes were proposed, the GLM's water master planners, GLS Consulting, included the preliminary layout in the updated George Water Master Plan 2022. This layout was then taken forward for modelling the preliminary design scenarios described in the preceding sections of this report.

8.1.2 General arrangement of the planned infrastructure

Figure 26 shows the general arrangement of the proposed reservoir site. The various aspects depicted in this general arrangement are addressed under the following paragraphs:

- 8.3 Reservoir PWR-02
- 8.4 Pump station PWT-PS-02
- 8.5 Inter-connecting pipework
- 8.7.1 Access road
- 8.7.3 Fencing
- 8.7.4 Stormwater drainage and landscaping
- 8.1.3 Future phases (reservoir, towers and pumpstation)

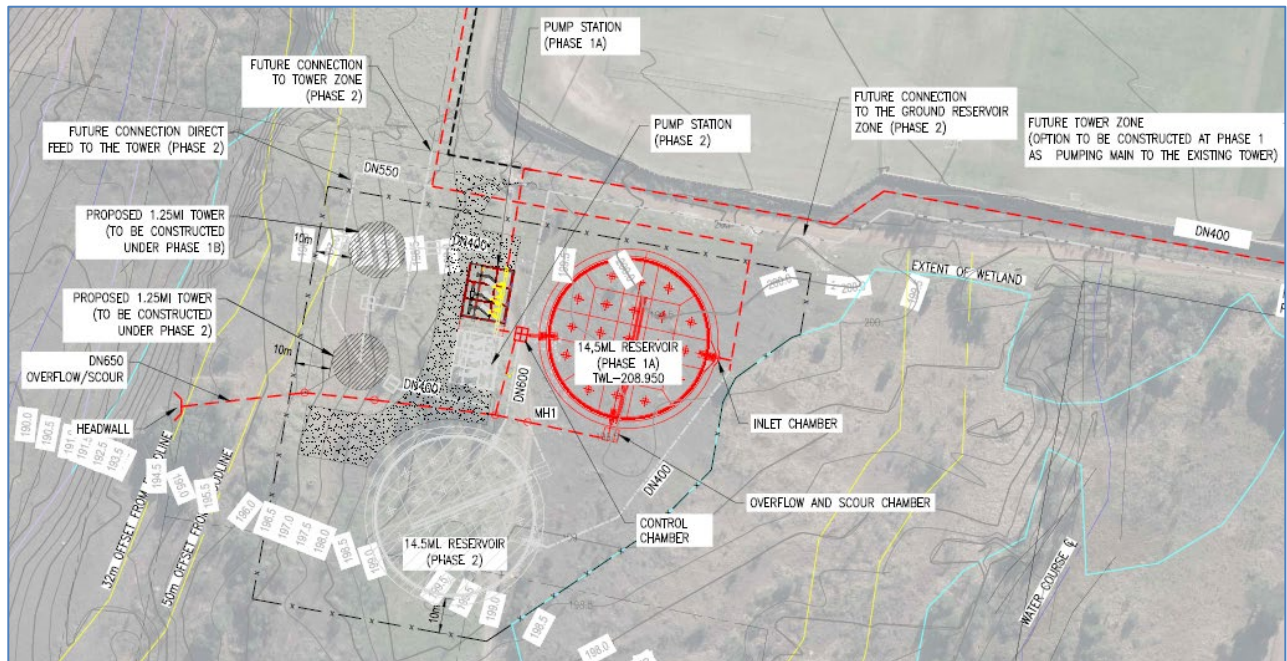

Figure 26: General arrangement of reservoir site (incl. pump station and provision for future reservoir and towers)



Figure 27: Rendering of reservoir site showing proposed Phase 1A reservoir and pumpstation as well as future phases

8.1.3 Future phases (reservoir, towers and pumpstation)

Future phases will be required to extend the infrastructure being planned for Phase 1A. This will include:

- 2 No. x 1,25 Ml elevated towers
- 1 No. x 14,5 Ml reservoir
- Upgrading of the pumpstation capacity

For Phase 1B it is proposed that a 1,25 Mℓ capacity tower (PWT-02) be implemented instead of the 2,5 Mℓ capacity tower reflected in the current planning. The reasons for this are:

- the significant capital investment required upfront to build a 2,5 Mℓ sized tower, of which 50% of the capacity would only be required 20 to 30 years in future;
- the practical, structural and constructability challenges involved in implementing a 2,5 Mℓ capacity elevated tower.

These aspects do not form part of the Phase 1A works and as such, apart from what is necessary to describe or limit Phase 1A, have not been addressed any further in this preliminary design report.

8.2 Design criteria

The design criteria for the proposed Phase 1A pipeline, reservoir and pumpstation and the related infrastructure is presented in **Table 16**. The table provides abbreviated references to some of the sources. These are:

<u>GLM DC Guidelines:</u>	George Local Municipality, Guidelines - development contributions for water
<u>Planning & design guidelines (J):</u>	Department of Human Settlements, The Neighbourhood Planning and design Guide: Section J (Water Supply)
<u>GLM Standards:</u>	George Municipality (Civil Engineering Services) Civil Engineering Standards and Requirements for Services, May 2016
<u>GLS Master plan</u>	Planning data, site layout and masterplan items as provided by GLS (J van der Merwe, 20 June 2022) – ref. Annexure F and Annexure G of this report

Table 16: Design criteria for Phase 1A infrastructure

No	Design aspect	Design criteria	Unit	Source
1	General			
1.1	Design horizon / period	50 years		As per client instructions
1.2	Access roads	Comply with Chapter 3		GLM Standards
1.3	Site drainage & stormwater	Comply with Chapter 4		GLM Standards
2	Pipeline			
2.1	Design Flow rate			
2.1.1	Incoming Bulk line to New Reservoir			
	Design Flow rate	381 l/s		GLS Master Plan, Annexure F
2.1.2	Pumping Main from New Pump Station to Existing Tower			
	Design Flow rate	150 l/s		Pump station Design
2.1.3	Direct feed to Existing Tower			
	Design Flow rate	39 l/s		GLS Master Plan, Annexure F
2.2	Pipeline start point			

No	Design aspect	Design criteria	Unit	Source
	Latitude (co-ord):	34° 0'43.33"S		MD3229-RHD-XX-GN-DR-C-0003
	Longitude (co-ord):	22°26'59.39"E		
2.3	Pipeline end point			
	Latitude (co-ord):	34° 0'49.96"S		MD3229-RHD-XX-GN-DR-C-0003
	Longitude (co-ord):	22°26'46.94"E		
2.4	Flow velocities			
	Preferred Max:	1.8m/s		GLM DC Guidelines, Addendum A1, Operational criteria, Flow velocities ¹
	Absolute Max:	2.2m/s		
	Special fittings:	6.0m/s *		Planning & design guideline (J), Hydraulic considerations ²
2.5	Minimum cover:			
	Road crossings:	0.800m		Planning & design guideline (J), Physical/structural
	Otherwise:	0.600m		
2.6	Pipe material			Refer to PDR Section 3.2
2.6.1	DN1000 – DN300	HDPE PE100 PN16		SANS 4427 (all parts)
		GRP Class 16		SANS 1748-1
2.6.2	DN300 or smaller	uPVC Class 16		SANS 966-1
		mPVC Class 16		SANS 966-2
		HDPE PE100 PN16		SANS 4427
3	Reservoir			
3.1	Top water level (TWL)	208.950m		Match existing reservoir TWL
3.2	Capacity			
	Minimum:	24 hours x AADD		Red book: From one water source
	Maximum:	48 hours x AADD		
	Design	36 hours x AADD		GLS Master plan
3.3	Average annual daily demand (AADD)			
	Initial (2022):	2.078 ML/d		Conclusions PDR Ch 6
	Final (+ 50 years):	20.145 ML/d		Conclusions PDR Ch 6
3.4	Required capacity	14.5 ML		As per client instructions & Conclusions PDR Ch 6
3.5	Reservoir plan shape	Circular		Conclusions PDR Ch 7
3.6	Construction material	Reinforced concrete		Conclusions PDR Ch 7
4	Pump station			

¹ Ref: "...Flow velocities must be limited... The preferred maximum allowed is 1,8 m/s, but an absolute maximum of 2,2 m/s is acceptable where only intermittent peak flows occur."

² Ref: "...velocities in the pipeline should be kept between 0.6 m/s and 1.2 m/s... Velocities through special fittings should not exceed 6 m/s or as per manufacturer's specifications."

No	Design aspect	Design criteria	Unit	Source
4.1	Pump station design duty			
	<i>(Note that this is PS duty and not duty per pump)</i>			
4.1.1	Existing Pump station			
	Flow (Q):	100l/s		Conclusions PDR Ch 6
	Head (H)	62.5m		Annexure I (Pump Data)
4.1.2	New Pump Station			
	Flow (Q):	150l/s		Conclusion PDR Chapter 6
	Head (H)	62m		
4.2	Minimum redundancy	n + 1		GLM DC Guidelines, Addendum A1, Operational criteria, Pump stations ³
4.3	Standby power (e.g. diesel generator)	None		Genset for PWT-PS-01 will provide the necessary standby capacity
4.4	Number of pumps (Phase 1A)			
	Duty:	1		1 duty and 1 standby (2 Pumps total) to be installed in Phase 1A. Third pump to be installed under Phase 1B is outside of this scope.
	Standby:	1		
	Installed:	2		
4.5	Pump type	Centrifugal		
4.6	Pump station type	Dry well		
4.7	Pump suction pipe level	2.5 m (below reservoir BWL)		Pump suction requirements (provisional)
4.8	Pump station construction			
4.8.1	Sub-structure:	Reinforced concrete below NGL		To suit existing PS ⁴
4.8.2	Super structure:	Reinforced concrete (columns and beams)		
4.8.3	Super structure infill:	Face brick		
4.8.4	Roof:	Pitched (timber truss)		
4.8.5	Roof cladding:	Tiled		

The standards and criteria listed elsewhere in this report (Chapter 3) were given within the context of the water demand analyses and the modelling and analyses for the reservoir and tower capacities.

The criteria tabulated in this section are listed as relevant to the preliminary design and as such relates in particular the components (pipeline, reservoir and pumpstation) that make up Phase 1A.

³ Ref: "...PS's should always have one standby pump available."

⁴ Interpreted from GM PDR discussion (24/05/2023) and aligned to suit existing pump station

8.3 Reservoir PWR-02

The following sections address the concepts and preliminary design of the proposed Phase 1 ground-based reservoir PWR-02. The Phase 1 ground-based reservoir PWR-02, with a capacity of 14,5 Ml, is proposed to be located approximately 600 m away from the existing PWR-01 reservoir site, and to the south west of the sport grounds. Note that this site was referred to as Option B in the previous reporting, but now is referred to as “the new reservoir site”.

8.3.1 Reservoir geometry

Based on the design criteria provided, the new Pacaltsdorp West reservoir will be a 14.5 ML circular⁵, reinforced concrete reservoir with a top water level of 208,950 m above mean sea level (amsl) to match that of the existing reservoir PWR-01. The following paragraphs describe, both in text and graphically, the preliminary design details for this reservoir.

8.3.1.1 Reservoir shape

The new reservoir will be circular. This follows from the prior option analysis (circular vs rectangular) and is as set out in the design criteria.

8.3.1.2 Water depth and freeboard

The reservoir will have a water depth of 9,250 m. This water depth has been selected in order to minimise the depth of the engineered fill layer between the reservoir floor and the founding level.

A freeboard of 350 mm has been allowed between the top water level (TWL) and the soffit of the roof slab.

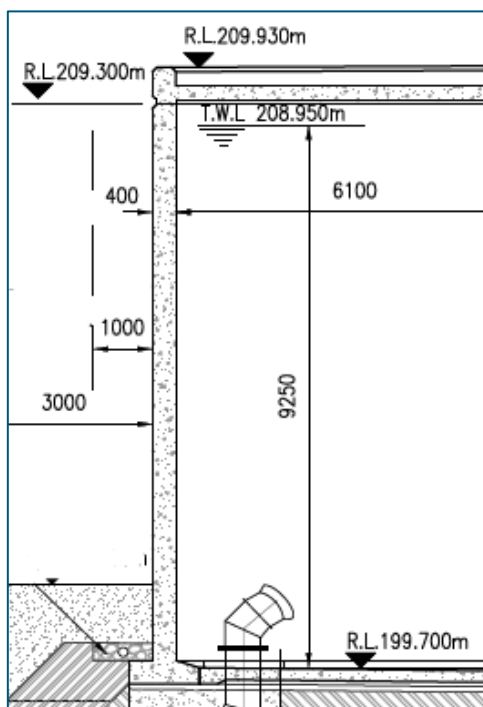

Figure 28: Typical reservoir wall cross section showing water depth and total wall height

⁵ An option analysis for rectangular vs circular reservoir was undertaken and is detailed in this report. This option analysis concluded that a circular reservoir would be the preferred reservoir plan shape.

8.3.1.3 Reservoir diameter

As discussed in section 7 of this report, the depth of a circular reservoir can more easily be increased without a large cost premium, in order to match the reservoir's TWLs. As discussed in the preceding section the increased depth can be employed to match the TWLs instead of raising the foundation level.

In that case, the circular structure will be approximately 10 m high with an internal diameter of 45 m (for a water depth of approximately 9,25 m as above).

For this configuration, the total area (footprint) of the reservoir will be approximately 1 700 m².

8.3.2 Reservoir walls, floor, columns, roof slab

The reservoir will have a flat concrete roof supported by reinforced concrete columns. The roof will be supported on but not attached to the reinforced concrete wall. Similarly, the reinforced concrete floor will not be attached to the wall and footing.

- Walls: The reservoir walls will (provisionally) be approximately 400 mm thick and 9,6 m high (from footing to top of wall)
- Footing: The walls will be supported on a 1200 mm wide footing
- Floor: The floor will be 200 mm thick with thickenings where the floor adjoins the footing
- Columns: A total of 21 circular reinforced concrete columns will support the roof slab. The columns will in turn be supported in reinforced concrete footings. The column heads will be conical (i.e. where column meets roof slab).
- Roof slab: A (preliminary) 200 mm thick reinforced concrete roof slab will cover the reservoir. The roof slab will be supported in the circular columns and (with sliding joint) on the reservoir walls. The roof slab will have an integral upstand beam with a cross section of 600 mm deep x 400 mm thick.

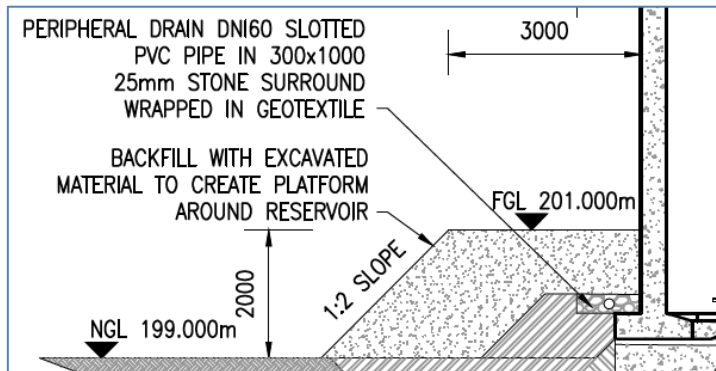

Figure 30: Typical section showing proposed detail for peripheral drain

8.3.3.2 Roof covering

A 75 mm thick layer of 40 mm washed aggregate will be placed on the completed reservoir roof.

8.3.3.3 Ventilation outlets

Ventilation outlets will be provided on the reservoir roof. The final number, position and detail will be determined during the detail design stage.

8.3.3.4 Measures for achieving watertightness

The primary means of ensuring watertightness of the structure will be the specification for and quality of concrete used in the construction of all water-retaining elements. Factors that will be addressed in the detail design and in the specifications will include:

- Suitable materials (cement and aggregates)
- Appropriate cement:water ratio
- Limiting the types and quantities of permissible admixtures
- Specifying stringent curing requirements
- Requirements for watertightness testing

It is generally considered best practice to provide further measures to ensure watertightness of the structure – i.e. apart from ensuring that high-quality, durable concrete is provided. The measures that will be incorporated into the final reservoir design will include:

- Rubber waterstops in the bottom of the reservoir floor joints (“rear-guard” waterstops)
- Rubber waterstops in the centre of wall joints (“dumbbell” waterstops)
- Flexible waterproofing tape in the surface of all wall and floor joints

8.3.3.5 Bearing pads (wall-roof joint)

The design of the reservoir wall-roof interface requires that the ring beam (an upstand beam integral to the roof) be allowed to move freely in the horizontal plane. This sliding joint is needed to ensure that the wall and roof can expand and contract without resulting in damage to the structure.

In order to achieve this sliding joint bearing pads or strips must be installed on the prepared surface (top of wall). The top of the wall requires special preparation and must be floated to a glassed finish.

8.3.3.6 Reservoir floor drainage

A central drainage channel will be provided in the reservoir floor. This channel will be 23,7 m long and 500 mm wide with a floor sloping towards the scour outlet.

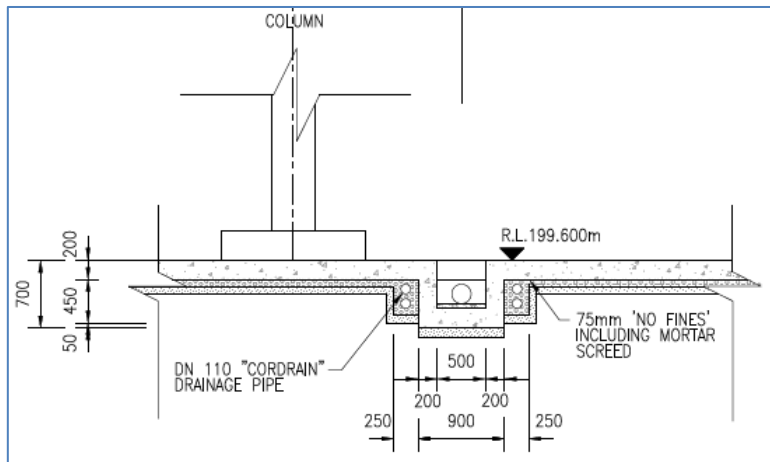

Figure 31: Typical section through reservoir drainage channel (outlets to scour)

8.3.4 Structural and geotechnical considerations

8.3.4.1 Structural design codes

The structural design of the reservoir is to be carried out in accordance with the requirements of the following codes of practice:

- BS 8007 – Code of practice for design of concrete structure for retaining aqueous liquids
- SANS 10100-1:2000 – The Structural Use of Concrete Part 1: Design
- SANS 10144:1995 (formerly SABS 0144:1995) – Detailing of reinforcing for concrete

8.3.4.2 Geotechnical aspects

The geotechnical investigation by Outeniqua Geotechnical Services (OGS, 2022) found that the foundation design for a water retaining structure (“tank structures”) would need careful consideration, and improvements:

- in the form of the removal of unsuitable material,
- construction of an engineered fill layer, and
- provision of improved stormwater drainage.

Selected excerpts from the report relating to the foundation and provisions for stormwater drainage are provided below (with emphasis added where relevant).

“Foundations

...Site testing indicates the presence of potentially problematic soils, mainly including deposits of uncontrolled fill (possibly up to 2m thick in places), which could result in settlement of structures if improperly founded. The impact of this is the requirement for mitigation measures to treat or remove unsuitable soil from below the proposed structures, possibly involving additional excavations and replacement with engineered fill, depending on founding levels. The recommended improvements include removal and replacement of unsuitable fill material where it occurs below foundations, stiffening of foundations with steel reinforcement, and/or improved site drainage measures.

.....Alternative foundation systems include raft/slab-on-grade foundations (e.g. for tank structures) on an engineered platform, consisting of at least 0.5m of imported G5, compacted to 95%MDD, depending on founding levels.

Stormwater

Good site landscaping and a piped underground stormwater management system is recommended to collect, divert and control the discharge of stormwater from structures, hard surfaces and roads to prevent flooding and ingress into subsoils, which could affect the stability of the soils below structures and roads, causing settlement or other stability problems."

Based on the findings and recommendations from the geotechnical investigation report, the following approach is proposed:

- excavate to depth of approximately 2 m below ground level over the entire structure footprint;
- the excavated material can be stockpiled for use as fill around the reservoir and for site landscaping;
- remove all unsuitable material as determined on site by the geotechnical engineer (who should be in attendance for this purpose);
- prepare all surfaces with 150 mm in-situ preparation, ripped and re-compacted to 93% MDD;
- replace any unsuitable material with fill up to the excavation level – using G5 material placed in 175 mm layers and compacted to 95% MDD;
- construct first engineered fill layer 1000 mm thick, using crushed stone G5 compacted in layers 175 mm thick;
- construct second engineered fill layer 500 mm thick, using crushed stone G5 compacted in layers 175 mm thick, on a basal reinforcement geogrid ("Rockgrid");
- construct final engineered fill layer 500 mm thick, using crushed stone G4/G5, stabilised to C4 with 5% cement, compacted in layers 175 mm thick, on a basal reinforcement geogrid ("Rockgrid");
- note total engineered fill layerworks: 1000 mm G5 + 500 mm G5 + 500 mm C4 = 2000 mm;
- implement subsoil drainage that discharges to the underground stormwater drainage system – to ensure that the structural engineered fill layer is protected from water ingress.

Note: The general approach outlined above must be applied equally to the proposed new pumpstation.

The sketch below illustrates the 1 m deep foundation excavation, the in-situ preparation, the engineered fill and the reservoir wall section.

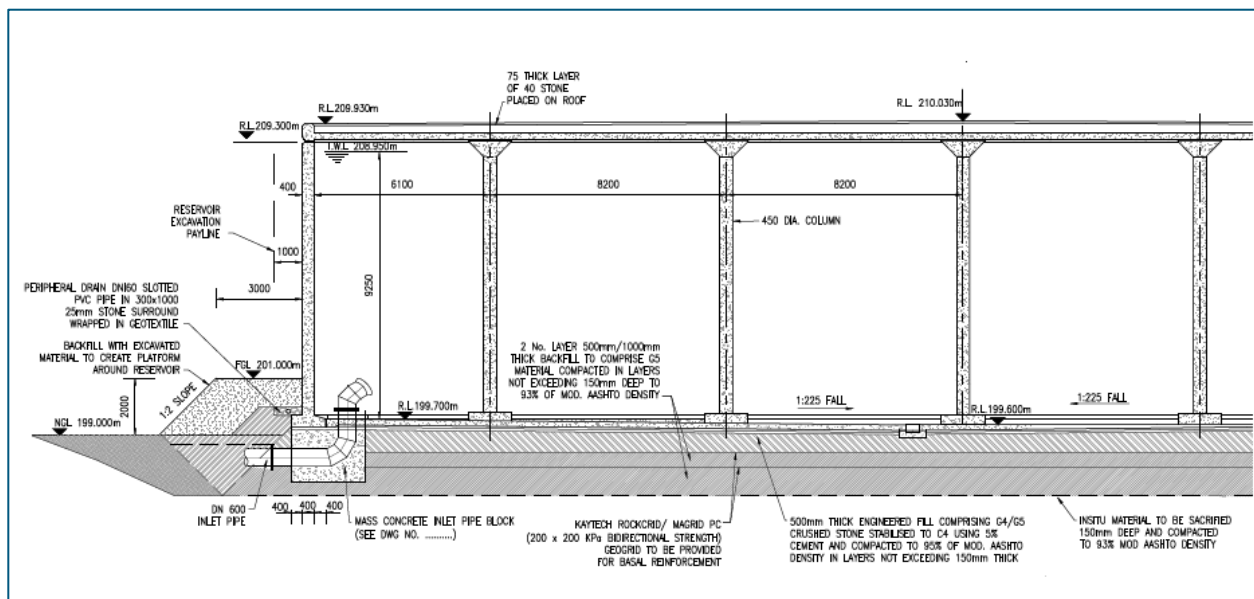

Figure 32: Partial section through reservoir showing foundation details

8.3.5 Reservoir pipework

The additional infrastructure associated with the new reservoir site includes pipework, fit tings, valves, control valves and meters, as well as the chambers and appurtenances required for these items.

The new reservoir is proposed to have the following main pipework items:

- an inlet
- an outlet
- an emergency overflow
- a scour outlet
- inlet and outlet isolating valves
- an inlet control valve, installed in the main valve chamber
- the inlet and outlet pipes will be in the size range DN600 to DN900

8.3.5.1 Pipe materials

Pipework that is cast into the main reservoir structure, and/or submerged pipework, shall be manufactured from stainless steel. Other pipework shall generally be manufactured from mild steel, with epoxy coating and lining.

Flanges at the inlet and outlets to the reservoir shall be separated with insulating flanges for corrosion protection (e.g. where the pipe material changes from stainless steel to mild steel).

Outside of the reservoir battery limits the pipework (i.e. the inter-connecting pipeline addressed in 8.5) will revert to the pipe material selected for the pipeline (provisionally HDPE). The transition between the HDPE pipeline and the steel reservoir pipes (inlet and outlet) will be made by way of and HDPE stub, backing ring and flange on the HDPE and a welded flange on the steel pipes.

8.3.5.2 Reservoir inlet

A DN600 inlet is planned for the reservoir. The bottom inlet pipe is cast into a mass concrete block and the cast-in fittings will be required to be stainless steel. A bottom inlet arrangement has been selected in this instance as bottom inlets are considered to be the convention⁶. A flared inlet pipe will be connected to the cast-in pipe and will allow the flow of water at the inlet to be directed for proper circulation.

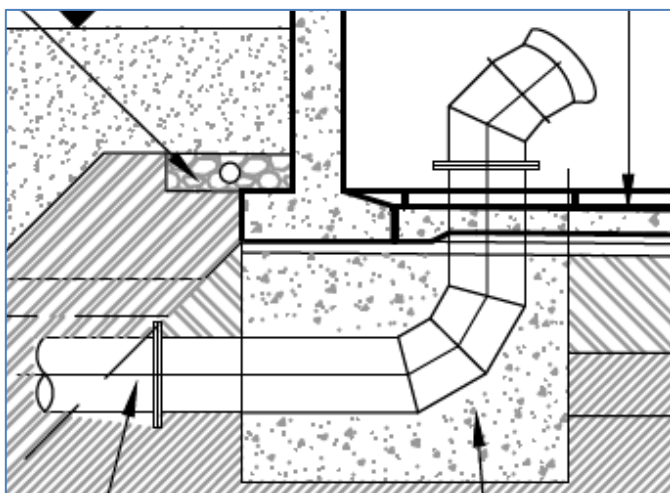

Figure 33: Typical section showing reservoir (bottom) inlet cast into mass concrete pipe block

The reservoir inlet will be provided with a reinforced concrete chamber to house the inlet valves (check valve and isolation valve).

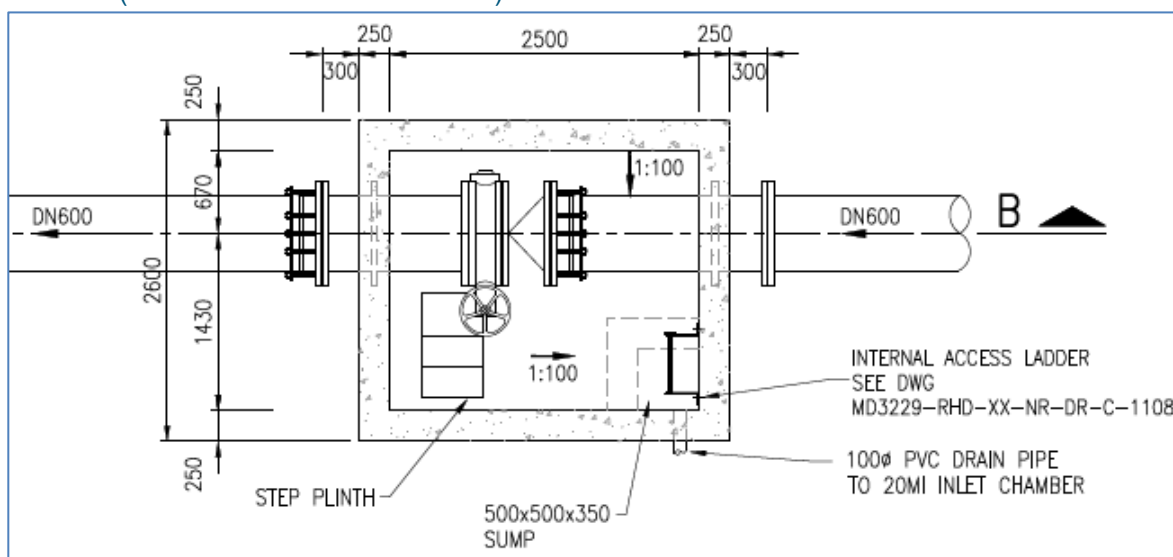

Figure 34: Sectional view of reservoir inlet chamber

8.3.5.3 Reservoir outlet

A DN600 outlet pipe is planned for the reservoir. The outlet pipe is cast into a mass concrete pipe block and the cast-in fittings will be required to be stainless steel. The outlet level will be 100 mm

⁶ RHDHV Best Practice Guideline R050: "...Bottom entry reservoirs are conventional and have the advantages that: ...The inlet control valves are situated below the floor level of the reservoir, usually in an access culvert or chamber...The total amount of available energy in the gravity supply pipeline can be utilized to maximize the flow capacity of the pipeline...Water does not cascade into the reservoir..."

above the finished floor level of the reservoir. This will help reduce the amount of sediment collected by the outlet. A 1500 x 1500 mm outlet screen is secured to the floor over the inlet pipe

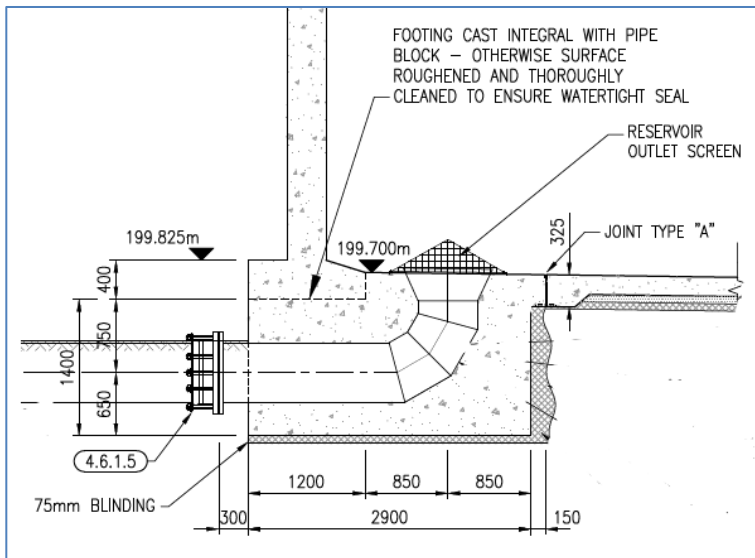

Figure 35: Typical detail showing reservoir outlet pipe cast into mass concrete pipe block

The reservoir outlet will be provided with a reinforced concrete chamber to house the outlet valves (isolation valve and a scour).

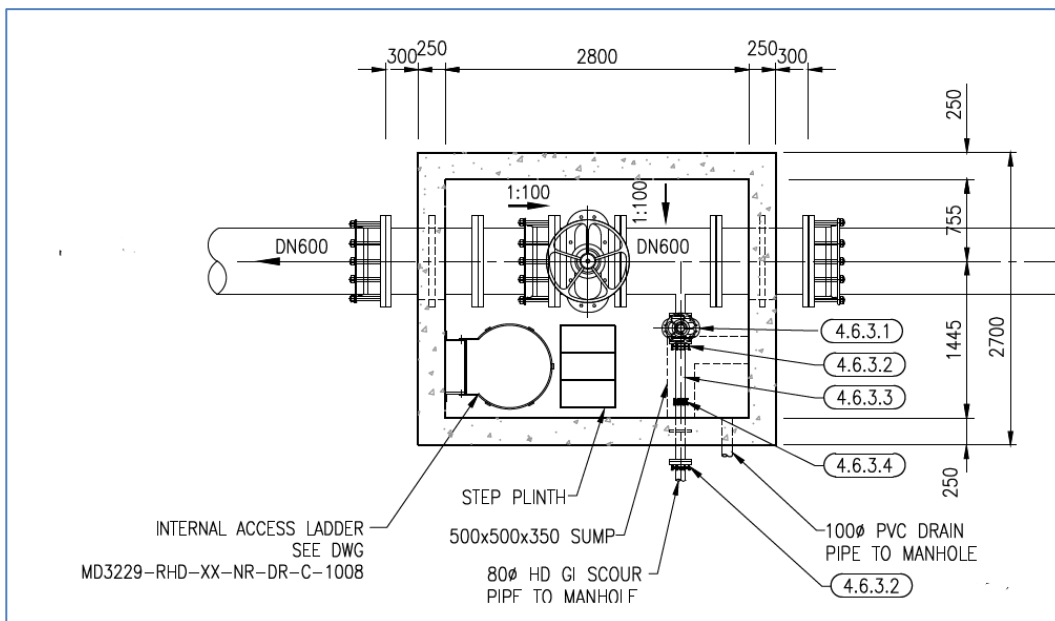

Figure 36: Sectional view of reservoir outlet chamber

8.3.5.4 Emergency overflow and scour outlet

The scour and the emergency overflow are dealt with as a single topic as these two adjacent lines ultimately discharge to a common chamber and the resulting flow is conveyed via a common drainage pipe to the discharge point.

A **DN600 emergency overflow** must be provided. The vertical bend of the overflow is cast into a mass concrete pipe block and the cast-in fittings will be required to be stainless steel. The overflow

pipe will extend to the top water level where it will be equipped with a bellmouth outlet and a cowl. The overflow pipe, which is a substantial pipe of 600 mm diameter and 9050 mm long, must be supported by stainless steel brackets and clamps that are secured to the reservoir wall.

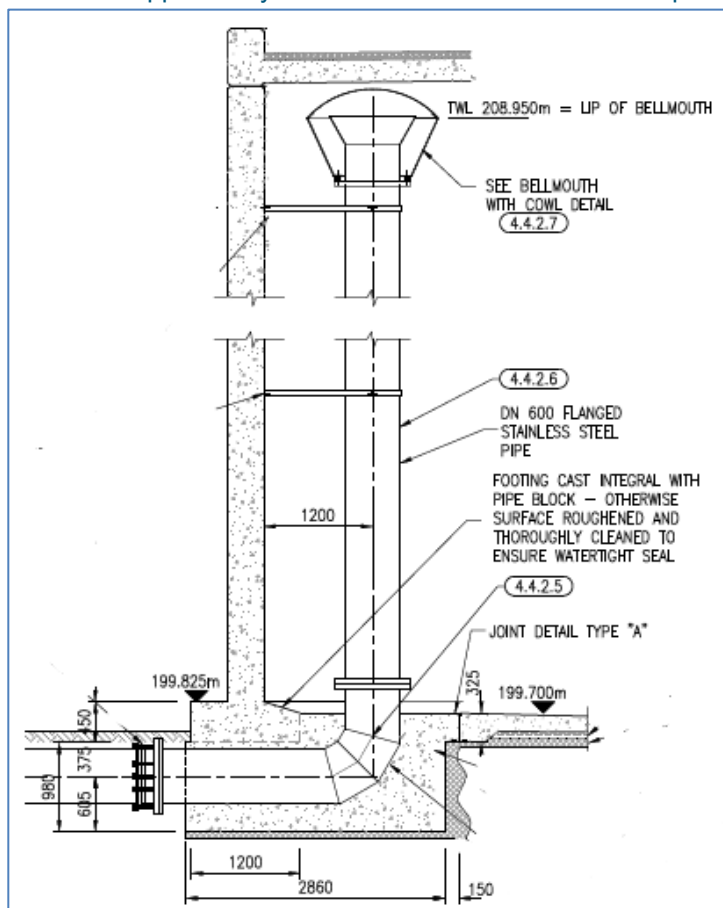

Figure 37: Preliminary detail for emergency overflow

The **DN400 scour outlet** will be cast into a mass concrete pipe block in the reservoir floor. The outlet will be situated below the finished floor level of the reservoir, thus allowing the structure to be fully drained, and will collect water from a central drainage channel in the reservoir floor.

The isolation valve for the scour outlet will be located in a chamber that is adjacent to and shares a common wall with the overflow chamber (see Figure 38). The scour discharge pipe will discharge into the overflow chamber.

The overflow chamber will provide a collection point for various drainage pipes. These will include:

- the emergency overflow (DN600)
- the scour outlet (DN400)
- a rain water collection pipe (DN200)
- drainage pipes from the subsoil drainage (2 x DN160)
- drainage pipes from the peripheral drain (2 x DN110)

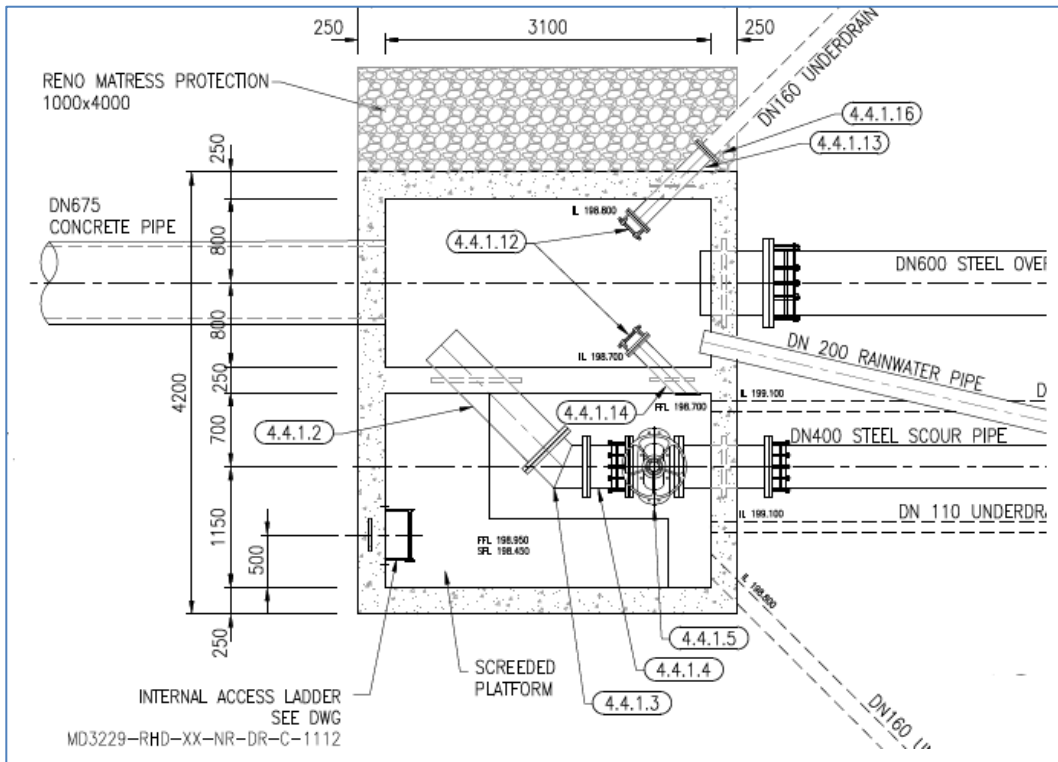

Figure 38: Sectional view of scour and emergency overflow chambers

A 675 mm diameter concrete pipe will convey the flow from these outlets and drainage pipes from the overflow chamber to suitable discharge point near the adjacent watercourse. The discharge will be provided with a headwall and energy dissipation measures to mitigate against localised erosion during scouring and overflows.

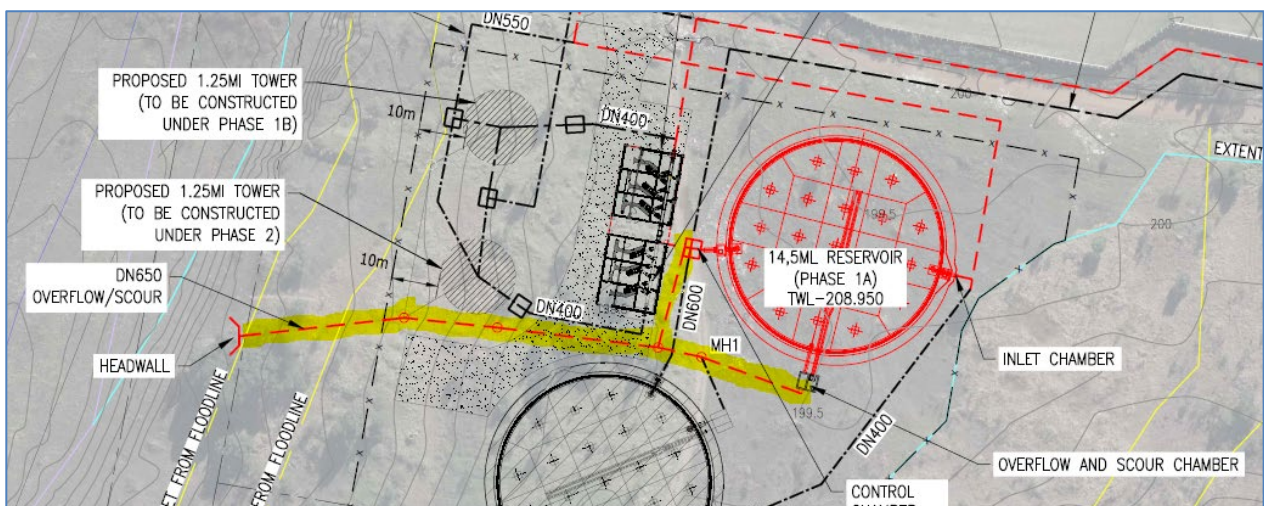

Figure 39: Preliminary drainage pipe route from overflow and control chambers to discharge point (route highlighted)

8.3.5.5 Valves

Table 17 provides a summary of the valves and/or controls that must be provided on the various inlet and outlet pipes.

In all instances the valve sizing is given as being equal to the pipe diameter. However, there may be scope (particularly with the larger diameters, i.e. DN600) to reduce the valve sizes in some instances. The DN600 valves could potentially be reduced to DN450, which would result in a cost saving.

The appropriate valve sizes must be investigated during the detailed design stage when the pipeline hydraulics and pipe sizing are finalised. Any reduction in valve sizes must be supported by hydraulic analyses to demonstrate suitability. These considerations will apply equally to the pumpstation and the inter-connecting pipelines.

Table 17: Summary of valves and meters on inlet and outlet pipework

Position	Pipe	Function	Valve Size
Inlet	DN600	Isolating valve (butterfly)	DN600
		Check (non-return) valve	DN600
		Control valve	DN400*
Outlet	DN600	Isolating valve (butterfly)	DN600
		Flow meter	DN400*
		Scour valve (wedge gate)	DN80
Scour	...	Isolating valve (butterfly)	DN400
Overflow	DN600	No valve – free overflow via bellmouth with cowl	n/a

8.3.5.6 Valve chambers

Chambers will be required on the inlet, outlet, overflow and scour to house the valves and/or terminal pipes. The valve chambers will be reinforced concrete structures. They will generally be equipped with the following:

- A reinforced concrete cover slab with ventilation where appropriate
- Steel access cover (1250 x 1250 mm) and frame cast into roof slab
- Internal access ladders
- Grab handle cast into cover slab to assist entry/exit from ladder
- Drainage sump with an outlet connected to a central collection network
- Supports for pipes and fittings
- Access steps to provide access to handwheels (where necessary)

8.4 Pump station PWT-PS-02

The function of the new pump station PWT-PS-02 will be to transfer potable water from the new reservoir PWR-02 to (initially) the existing water tower PRT-01 and (eventually) the new water towers PWT-02 and PWT-03.

The new pump station PWT-PS-02 will be located at the new reservoir site and within the same fenced perimeter as the new reservoir. It is proposed that the pumpstation be implemented in two phases. The new pumpstation will supplement the capacity provided by the existing pumpstation PWR-01, which will remain operational and continue to supply the existing water tower PWT-01.

8.4.1 Phased implementation of pumpstation

As noted in the introduction to this section, the new pumpstation will be implemented in two main phases. In brief the approach will be as follows:

- A new pump station PWT-PS-02 will be constructed at the same time the new 14,5 Ml reservoir PWR-02 is constructed (i.e. both under Phase 1A).
- This new PS will initially transfer the water from the new PWR-02 reservoir to the existing tower PWT-01. Ultimately the new PS will transfer the water to the new tower PWT-02 once the latter is constructed.
- The pumps provided under Phase 1A are to be sized to initially pump the same flow as the existing PWT-PS-01, i.e. approximately 100 l/s.
- The pumpstation will be equipped under Phase 1A with 1 duty pump and 1 standby pump.
- In Phase 1B a third pump will be added to the pumping equipment installed under Phase 1A and this will increase the number of duty pumps from 1 to 2.
- In the next phase (i.e. Phase 2) the pumps and pump station will be upgraded to pump the ultimate flows (approx. 314,7 l/s) to the new elevated tower PWT-02 (and PWT-03 if this is phased in two phases).

To accommodate this phased approach it is proposed that the pumpstation be constructed with a pump pit for Phase 1A, a pump pit for Phase 1B and a common area to house the electrical equipment and switchgear, controls and instrumentation.

In Phase 1A the pumpstation will be equipped with 2 pumps: 1 duty and 1 standby. In phase 1B a third pump set will be added, bringing the number of pumps in that bay to 3 (2 duty and 1 standby). This will ultimately be duplicated in the second pump pit, bringing the total number of installed pumps to six (6). The pumpstation will ultimately be equipped.

There will be little economy in initially installing common infrastructure, e.g. power supply cabling, common suction and common header pipes, to suit the initial lower flows. The common civil, building, pipework and power supply infrastructure must therefore be designed to accommodate the ultimate pumped flows needed for the future supply to the combined tower PWT zones (approx. 314,7 l/s).

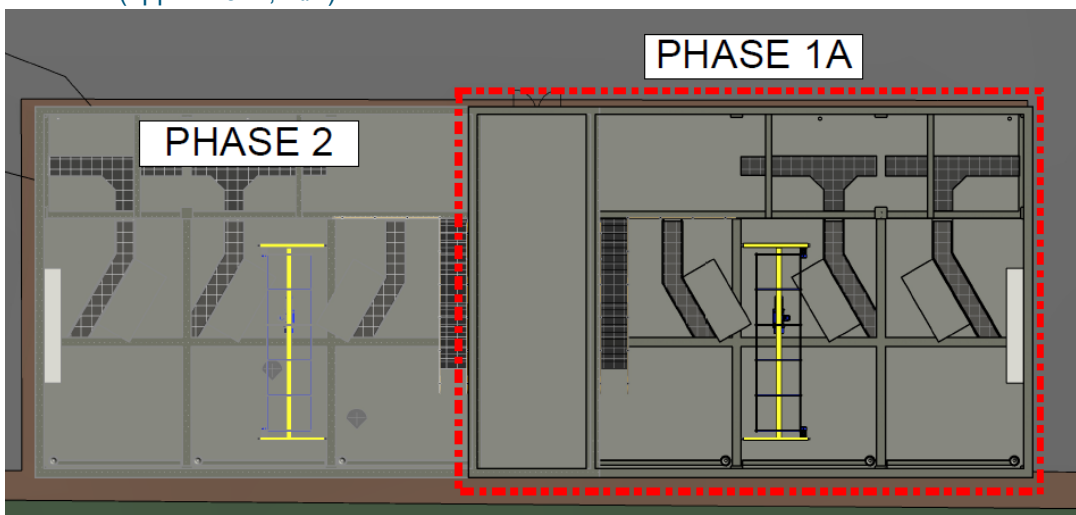

Figure 40: Concept pumpstation layout (Phase 1A and 1B)

The following work will be undertaken in Phase 1B:

- A new pump set incl. all related cabling, pipework, instrumentation and controls will be installed in the pump house that was constructed under Phase 1A. This will increase the pumping capacity to 2 duty pumps and 1 standby – i.e. a total of 3 pumps installed. (see also Figure 43: Preliminary layout of pump station pipework (showing pump sets 1 & 2 under Phase 1A))

The following work will be undertaken in Phase 2:

- Construct civil and building extensions (sub-structure and superstructure) to accommodate second pump pit equipment (three pumps);
- Install new pump sets to achieve ultimate flow (approx. 314,7 l/s) - i.e. third pump set for original pump pit and 3 new pump sets in new pump pit;
- Install new suction and delivery pipework for new pump sets and extend common header and delivery pipework to accommodate upgrade;
- Install new MCCs, power cabling, instruments and related to the new pump sets and related.

8.4.2 Existing pump station

The existing pumpstation PWT-PS-01 has the capacity to deliver up to 100 l/s to the existing tower PWT-01. PWT-01 can then supply the required demands to the tower zone during the implementation phase of the new PWR-01 reservoir.

For the near future (next 5 to 10 years) the existing pumps do not need to be upgraded as the demand from the tower supply zone will still be within the capacity of the existing pumpstation. It is therefore not necessary to upgrade this pump station in the short to medium term.

The existing pump station PWT-PS-01 details are provided in **section 5.4** (Pump Station PWT-PS-01).

8.4.3 Pump house (structure)

The new pump house must accommodate the pump sets and all related piping, fittings, cabling, MCCs, etc.. The pumpstation must also be so configured as to ensure that the net positive suction head (NPSH) requirements for the pumps are fulfilled at all reservoir water levels. To achieve these requirements it is proposed that the new pumpstation provide for the pumps to be situated below ground level (and hence also below the reservoir floor level) with the MCCs and related equipment located at ground level. The layout of the new pumpstation will thus be similar to the existing PWT-PS-01.

Preliminary details for the pump station are as follows:

- Reinforced concrete pump pit below ground level (floor level approximately 2,5 m below the bottom water level of the new reservoir);
- All below-ground elements to be reinforced concrete;
- Above ground structure to consist of reinforced concrete columns and a ring beam beams with brickwork infill between the columns and the ring beam;

- A crawl beam will be required (**see Section 8.4.7 Lifting equipment**) and this will be hung below ring beam and cross beams (not attached to timber roof structure);
- The roof will be a pitched roof of timber trusses clad with roof tiles.

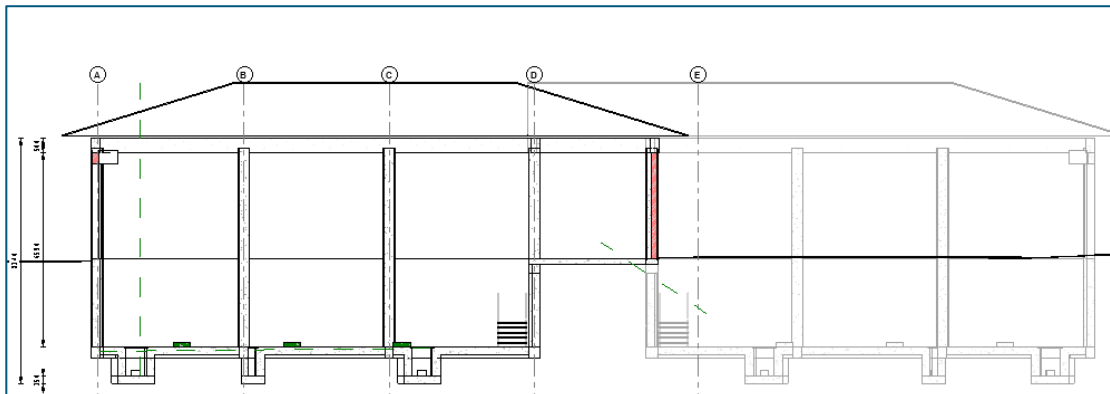

Figure 41: Section through concept pump house (showing extension that will be done under Phase 2)

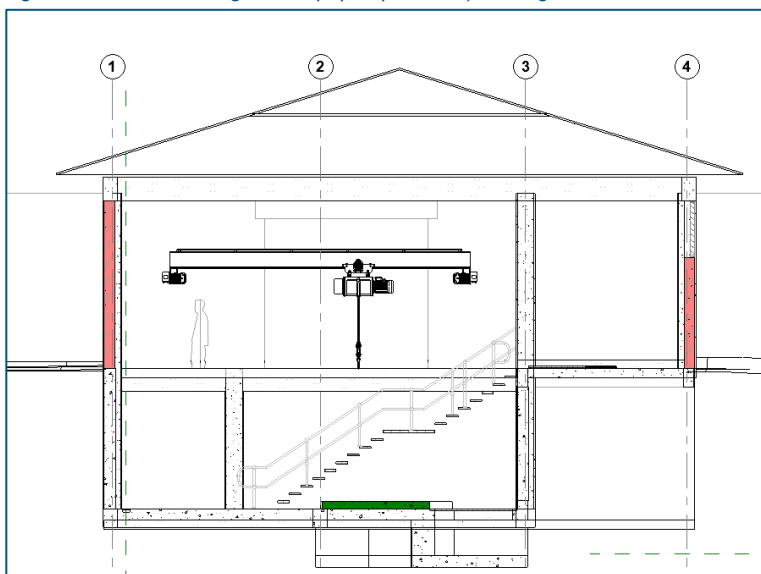

Figure 42: Cross section through concept pump house showing pump pit below ground level

8.4.4 Foundation preparation

The foundation preparation for the new pump house structure must follow the same basic principles as set out for the reservoir.

In this instance the depth of excavation may be greater than for the reservoir, as the floor of the pump house will be approximately 2,5 m below the reservoir bottom water level. The reservoir bottom water level will be 199,800 m (m msl) and the pump pit finished floor level will then be $199,800 - 2,500 = 197,300$ m msl. Assuming a floor thickness of 300 mm and an engineered fill layer of 500 mm thick, the foundation level for the pump house will be 196,500 m msl.

The general foundation preparation approach for the pump house will then be:

- Excavate to a foundation level (approximately 196,500 m msl) over the entire structure footprint;

- the excavated material can be stockpiled for site landscaping, but any excess material will need to be spoiled;
- remove all unsuitable material from the foundation excavation as determined on site by the geotechnical engineer (who should be in attendance for this purpose);
- prepare all surfaces with 150 mm in-situ preparation, ripped and re-compacted to 93% MDD;
- replace any unsuitable material with fill up to the founding level – using G5 material placed in 175 mm layers and compacted to 95% MDD;
- construct engineered fill, 2000 mm thick (1000 mm G5 + 500 mm G5 + 500 mm C4) as per the detail provided for the reservoir;
- implement subsoil drainage that discharges to the underground stormwater drainage system – to ensure that the structural engineered fill layer is protected from water ingress.

8.4.5 Pumping equipment

The initial (Phase 1A) pump installation will consist of 1 duty and 1 standby pump delivering a flow of 100 l/s at a total manometric head of approximately 50 m.

It is proposed that the pump station be equipped with centrifugal (end suction) pumps each paired suitable electrical pump motors. Indicative pump curves (head/flow, efficiency, NPSH, power) for a potentially viable pump are provided in Annexure I.

Based on the required duty point and assuming an efficiency of around 80% (as is typical for the proposed pumping equipment), the minimum pump motor size will be in the order of 90 kW.

8.4.6 Pumpstation pipework and fittings

The pumpstation pipework is to be manufactured from mild steel, with epoxy lining and coating. The pipes and fittings must have flanged connection. The pumpstation will consist of the following pipework and fittings:

- A common suction header (DN600)
- Suction (Intake) pipework branching to each pump (DN350)
- Suction isolation valves (DN350)
- Delivery (discharge) pipework from each pump (DN300)
- Delivery isolation and non-return valves (DN300)
- A common delivery header pipe (DN600)
- Flow control valve on the common delivery pipe
- Flow meter on the common delivery pipe

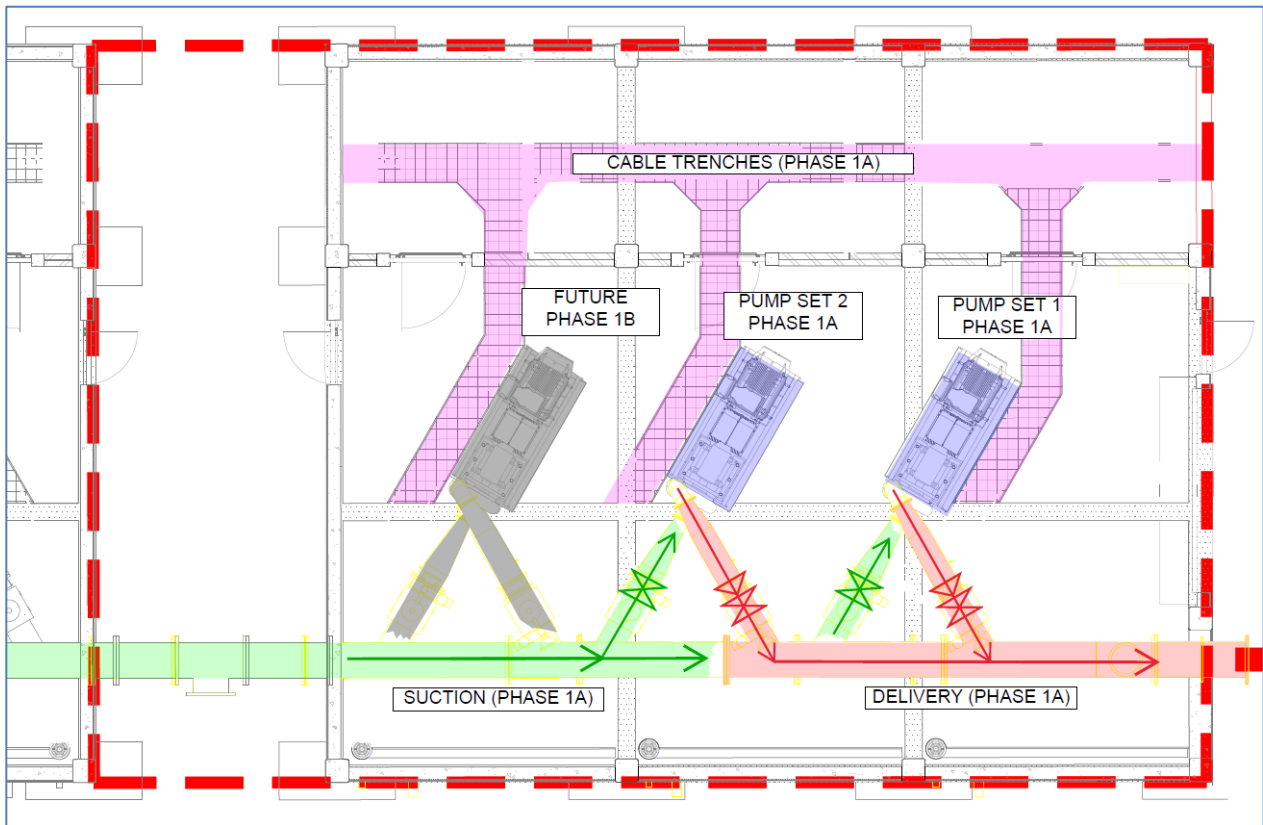

Figure 43: Preliminary layout of pump station pipework (showing pump sets 1 & 2 under Phase 1A)

8.4.6.1 Pipe materials

Pipework that is cast into the pump house structure must preferably be manufactured from stainless steel. Other pipework (within the pumpstation battery limit) should generally be manufactured from mild steel, with epoxy coating and lining.

Flanges at the inlet and outlets to the reservoir must be separated with insulating flanges for corrosion protection (e.g. where the pipe material changes from stainless steel to mild steel).

Outside of the pump station battery limits the pipework will revert to HDPE (as noted for the reservoir pipework).

8.4.6.2 Valves

Table 18 is a preliminary list of the valves that will be installed in and/or adjacent to the new pump station.

Table 18: Preliminary pump station valve list

Pipeline	Pipe dia.	Valve	Valve Size
Common suction	DN600	None	n/a
Pump suction	DN350	Isolating valve (butterfly)	DN350
Pump delivery	DN300	Non-return (check) valve	DN300
		Isolating valve (butterfly)	DN300

Pipeline	Pipe dia.	Valve	Valve Size
Common delivery	DN600	Isolating valve (butterfly)	DN600
		Flow meter	DN400*
		Control valve	DN400*

8.4.6.3 Cathodic protection

In the event that cathodic protection (CP) is required, flanges will have to be separated using insulating flanges to ensure that there is no continuity between the flanges.

8.4.7 Lifting equipment

Lifting equipment will be required for the installation, maintenance and removal of the pumping equipment and pipework.

The lifting equipment in the pumpstation will consist of:

- a crawl beam
- a trolley (or crawl)
- a chain block, hook and chains.

The lifting equipment should be manually operated with a safe working load (SWL) suitable for to lift a complete pump and motor.

8.4.8 Electrical power supply

Refer to **Section 8.6.1** (Electrical power supply).

8.4.9 Control and instrumentation

Refer to **Section 8.6.2** (Control and instrumentation).

8.5 Inter-connecting pipework

The interconnecting pipework routes between the existing PWR-01 reservoir site and the new reservoir site for PWR-02 and PWR-03, take into consideration the following:

- George water masterplan 2022 with Pacaltdorp West updated layout (see Figure 44);
- Facilitate connections and tie-ins required to existing bulk pipelines and those for future pipelines;
- Shortest available route, avoiding multiple bends;
- Avoiding clashes with existing infrastructure.
- A detailed breakdown of the pipelines and associated infrastructure as proposed in the George water masterplan can be found under Annexure F of this report.

Figure 44 has been taken from the George masterplan (GLS, 2022) and presents a draft layout for Pacaltdorp West reservoirs. This figure is of value here as it shows the connection (i.e. inter-connecting pipelines) between the existing 3 ML reservoir and the new 14.5 ML reservoir...”

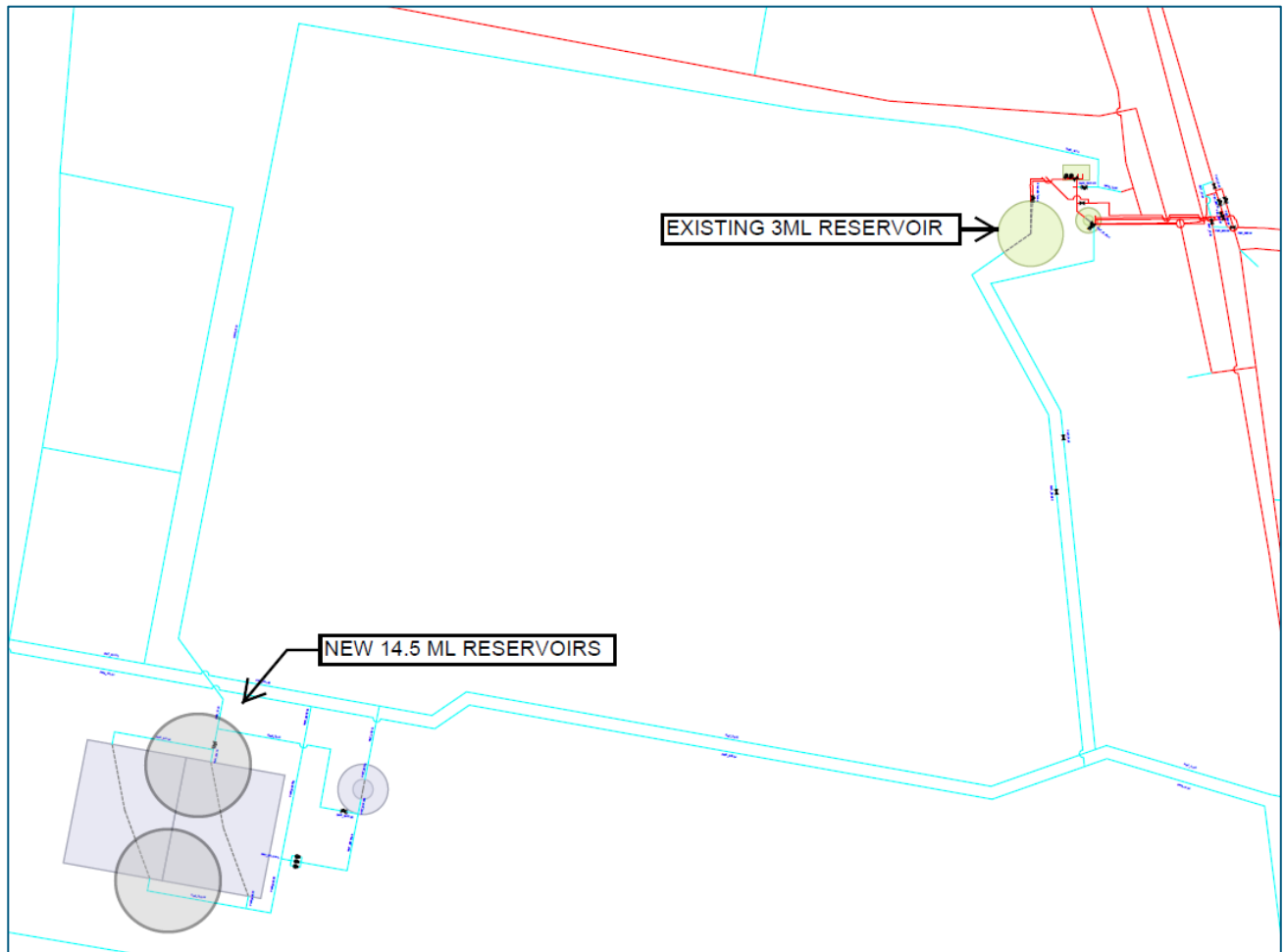

Figure 44: George masterplan – draft layout for Pacaltsdorp West reservoirs (GLS, 2022)

8.5.1 Main interconnecting pipelines

As discussed in section 5.1 (Bulk water supply system), reservoir PWR-01 can presently be supplied by two supply lines, a DN600 GRP pipeline (western line) and an older DN300 AC pipeline. In the masterplan, the DN300 AC pipeline is to be converted to an outlet pipe, and the DN600 bulk supply pipeline is the designated main supply to the Pacaltsdorp West water supply scheme. Further main pipelines are needed to convey water from the new reservoir site to the supply zones.

- The DN600 bulk supply pipeline, presently supplying the existing 3,0 Mℓ reservoir, will be extended in Phase 1 - to supply to the new reservoir PWR-02 site (including PWR-03 in the future).
- A future pipeline between the two reservoir sites may be required to connect the existing reservoir directly to the future new reservoir zone. This pipeline (masterplan ref. PWR-B02.05) can be routed along the abovementioned DN600 bulk supply pipeline route to the west, or on the east side of the sportsground, or along Beach Road. Therefore, space reservations are also being allocated for this possibility.
- With reference to below, it is proposed that the DN400 (PWT-02.02) outgoing supply pipeline (A) from the future new tower PWT-02 (Phase 2) to the PWT-Zone-02 connection point near Beach Road, be constructed under Phase 1. This pipeline is to be used during Phase 1, to transport water from the new reservoir and pumpstation to the existing tower site

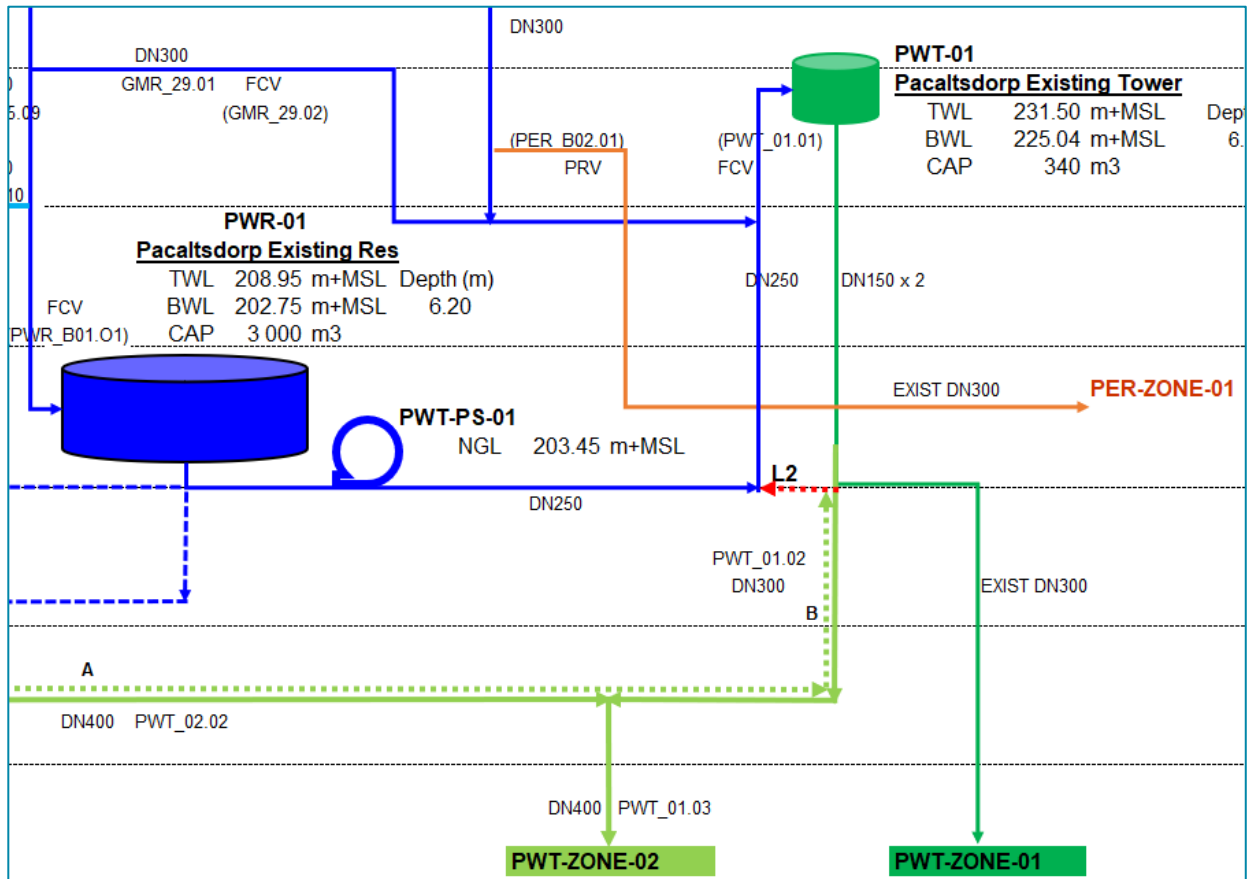

Figure 46: Schematic of temporary linked pipelines A and B near the existing reservoir site

8.5.2 Pipe material selection

GLM generally uses PVC pipes for water reticulation mains, connector mains and smaller bulk water pipelines up to DN300 in size. This simplifies operational repairs and maintenance.

The choice of pipeline material for the larger diameters is then between glass/fibre reinforced plastic (GRP), and high-density polyethylene (HDPE). The metallic options like mild steel, and ductile iron are not considered, as they require specialised coatings and linings, as well as cathodic protection.

In the recent past, the GLM have installed a number of GRP pipelines, and this is the “default” pipe material selected for large diameter pipelines in the GLM water masterplan. Clearly this is not an instruction to designers, but it does represent an economic option which is widely used and accepted.

However, GLM have had a number of operational issues with some of these GRP pipelines and particularly with the DN600 GRP (western line) pipeline that serves as the main supply to the Pacaltsdorp water supply scheme (ref. personal communication with operational staff).

The HDPE alternative must therefore be considered, and the following table summarises the pros and cons of the GRP and HDPE pipeline materials for the larger diameter pipelines.

Table 19: Pipe material comparison for large pipelines

Item	GRP	HDPE
Pipe size and pressure class	DN400 - DN 600 (PN16 pipelines) DN400 – DN 800 (PN6/10 reservoir outlet only)	DN400 - DN 600 (PN16 pipelines) DN400 – DN 800 (PN6/10 reservoir outlet only)
Bedding and laying	GRP pipe requires extreme care when bedding and installing backfill so that the pipe is properly supported and no damage is done to the pipe structure either by the backfill or the installation process.	HDPE pipe also needs care but it not as sensitive to laying because it has welded joints.
Joints	GRP is generally joined with a collar that relies on the pipe retaining its circular shape. Incorrect compaction of the pipe can cause joint problems and delay construction and commissioning.	Joint is commonly made using a butt weld process. These joints are not as susceptible to incorrect bedding and compaction.
Durability	GRP has good durability provided that the pipe walls is not damaged during manufacture, transportation and installation.	HDPE has excellent durability and abrasion resistance.
Experience	Only certain local GRP suppliers and contractors have significant experience and a good track record in the supply, training for installation (suppliers) and in the construction of large diameter GRP pipelines.	Experience with HDPE in most diameters is good, but is essential for the higher pressure and larger diameters.
Operational repairs and maintenance	GRP more easily damaged, and repairs are more expensive when damaged as surrounding and consequential damage more severe. Maintenance allowance for GRP estimated as 1% p.a.	HDPE pipe is thicker and significantly more malleable, resulting in less damage and in relative ease of repair Maintenance allowance for HDPE estimated as 0.2% p.a.
Cost	In general GRP pipe is less expensive than HDPE thus the choice to use GRP would attract lower capital costs. However, it is important to consider the increased construction risks when comparing the costs, as well as the long-term maintenance and repair costs.	Cost competitiveness between HDPE and GRP can fluctuate, depending on market conditions, oil price and strategic objectives when bidding for various projects and clients.

On balance, there is no clear “winner” in this comparison. However, there is merit in the argument for HDPE being easier and less costly to repair and maintain, and thus being preferred from an operational point of view in the long term. The initial savings in the cost of a pipeline are usually not fully appreciated when dealing with operational repair and maintenance issues later. In addition, for the clearwater rising main which is currently under construction at the George WTW, the material selected was HDPE.

Based on the discussion above, the preliminary recommendation is to use HDPE for the larger diameter pipelines (diameter greater than 300 mm). The pipe material must be reviewed in the detailed design phase with further input from GLM.

8.5.3 Valves and meters

Table 20 provides a provisional list of valves that are likely to be required for the inter-connecting pipeline. It is assumed that two (2) isolation valves will be required in order to isolate the pipeline at both the start and end connection points.

Table 20: Provisional valve list for inter-connecting pipeline

Pipeline	Pipe dia.	Valve	Valve Size	Quantity*
Inter-connecting	DN600	Isolating valve (butterfly)	DN600	2
		Air valve	DN150	2
		Non-return (check) valve	DN600	1
		Scour valve (Wedge gate)	DN200	1

**Quantities are provisional estimates only*

8.5.3.1 Valve and meter chambers

Valves and meters will be housed in reinforced concrete chambers. Chambers are to be in accordance with the George Municipality standards where these are applicable. The following must be taken into account in the detailed design of the pipeline chambers:

- The George Municipality guidelines require that valve chambers must be proud of the surrounding ground level. The RHDHV best practice guidelines similarly prescribe that chambers must be at least 100 mm proud of the surrounding ground level. The design of all chambers must accordingly provide for the cover level to be at least 100 mm proud of the surrounding ground level.
- Air valve chambers must be vented to ensure the proper operation of the air valve, particularly with regard to air intake during the draining of pipelines.
- Chambers must be provided with steel access covers, grab handles and access ladders.
- Chambers must be checked for general stability and in particular for stability against flotation.

8.5.3.2 Valve and pipe markers

The position of the pipeline (and where necessary the valves) must be marked by using permanent marker posts. The marker posts must be in accordance with the George Municipality standards.

8.6 Electrical, control and instrumentation requirements

The requirements for the electrical, control and instrumentation infrastructure are addressed under a single heading rather than under each component (reservoir, pumpstation, pipeline). Whilst the bulk of the electrical infrastructure will be focussed in the pumpstation (the pumps being the largest single power user), the control and instrumentation will effectively integrate the components into a pumping system.

8.6.1 Electrical power supply

Power supply arrangements must be put in place to provide power for the pumps and other equipment. The power supply infrastructure must provide for the following:

- Pumping equipment (ultimately 6 x 90 kW motors)
- Actuated valves (only likely to be required in the pumpstation)
- Power supply to flow meters and (potentially) to flow control valves
- Power supply to other monitoring instruments – e.g. pressure and flow instruments
- Ventilation and/or air-conditioning for the MCC area of the pump house
- Ventilation of the pump pit
- Small power and lighting in the pump house
- Area lighting within the reservoir site (e.g. floodlights and/or high-mast lights)
- Power supply for access control and security requirements (if needed)

Further particulars for the electrical power supply will be addressed in the detailed design report.

8.6.1.1 Power cabling in pump house

The power (and instrumentation) cabling in the pump house will be accommodated in cable trays.

Where the cables cross the pump house floor (i.e. in the final section before reaching the pump motors) they will be accommodated in cable trenches. The trenches will be provided with open-grid covers.

8.6.1.2 Standby power arrangements

Backup power is available in the form of a diesel driven standby generator at the existing pumpstation. For the interim (Phase 1A) the combination of the existing pumpstation's standby generator and the proposed method to directly feed the tower, is considered sufficient.

No additional standby power is planned to be installed under Phase 1A.

8.6.2 Control and instrumentation

Control and instrumentation (C&I) infrastructure will be required to ensure the proper operation, monitoring and protection of the pumpstation, reservoirs and water tower(s).

The C&I installations and programming will address:

- Pump (or pumping system) start-up, operating and shut-down procedures;
- Pump and motor monitoring and control (incl. parameters such as temperature and vibration);
- Flow monitoring (flow status and metering);
- Reservoir and water tower monitoring and control (flow, water levels, valve positions);
- Warnings and alarms for e.g. reservoir overflow and low water level.

- Telemetry requirements to allow data, including reservoir and tower water levels and pump status, to be communicated between the sites (old reservoir, new reservoir) and to other GLM locations for the management and control of the infrastructure.

8.6.2.1 Control philosophy

The Control philosophy for the reservoir, pipeline and pumpstation will be developed during the detailed design stage.

There are a number of other water tower arrangements in the George Municipality supply area and the municipality would ideally like to see a common approach taken to the control of these. In this regard it has been noted by the municipality that consideration might be given to a timer based means of controlling the pumping to the water towers. This must be addressed during the detailed design stage when the control philosophy is developed.

8.7 Site works

8.7.1 Access road

Two options exist for an access road to the site of the new Pacaltsdorp West Reservoir and pumpstation, namely;

- Option 1: The existing gravel road from Olympic road and along the western boundary of the Pacaltsdorp sport field, or
- Option 2: The track from Beach Road between the southern boundary of the sports field and the north of Pacaltsdorp cemetery to the site.



Figure 47: Potential site access road options

Once construction is completed the access road to the site will carry very little traffic. This needs to be considered when the surfacing requirement for the road is determined.

Surface road: George Municipality Civil Engineering standards and guidelines make it clear that chip and spray and Cape Seal will not be permitted as a road surface. In the event that a surfaced road is required (and use is limited to providing access to the reservoir site) it is proposed that the road be classified as a Class 5d road (Access Way – GM Guidelines) with the following specifications:

- Black top width of 4,5m with a crossfall;
- Kerb type CK5+MK10 (Crossfall);
- Minimum pavement layers of 150mm G7 selected layer, 150mm base (crushed stone) and a 25mm premix as surfacing;
- Final pavement layers to be determined during detail design.

Due to the low traffic this could potentially be an unsurfaced road. However, there are potential disadvantages to an unsurfaced road: (a) it will need regular maintenance and (b) the availability for proper wearing course material may be problematic in the George area. The advantage of an unsurfaced road it is that the initial cost will be lower and potential problems associated with bitumen based roads with low traffic can be avoided.

The potential does exist to align the access road so as to coincide with the internal roads of one of the future housing developments. **Figure 48** shows a future housing development labelled “A1” and situated directly adjacent to the sports field. The internal road for this housing development could potentially provide a viable route for the access road: i.e. the internal road could be serve a dual purpose as internal road for the housing development and access to the reservoir site. The proposed DN600 inter-connecting pipeline between the old reservoir and the new is intended to follow a similar alignment. With this in mind the approach could be:

- Provide for an interim access road aligned from Olympic road, via the planned “Class 4 PTR 18 m” onto the internal roads for development “A1” (route indicated in red on **Figure 48**)
- The road can initially be rudimentary but should at least provide for the sub-base and base layerworks described in the GLM Standards and would initially be unsurfaced;
- The pipeline should be aligned to take into account the future road width and services corridor;
- Once the housing development proceeds, the permanent, surfaced road can be implemented over the interim access road alignment.

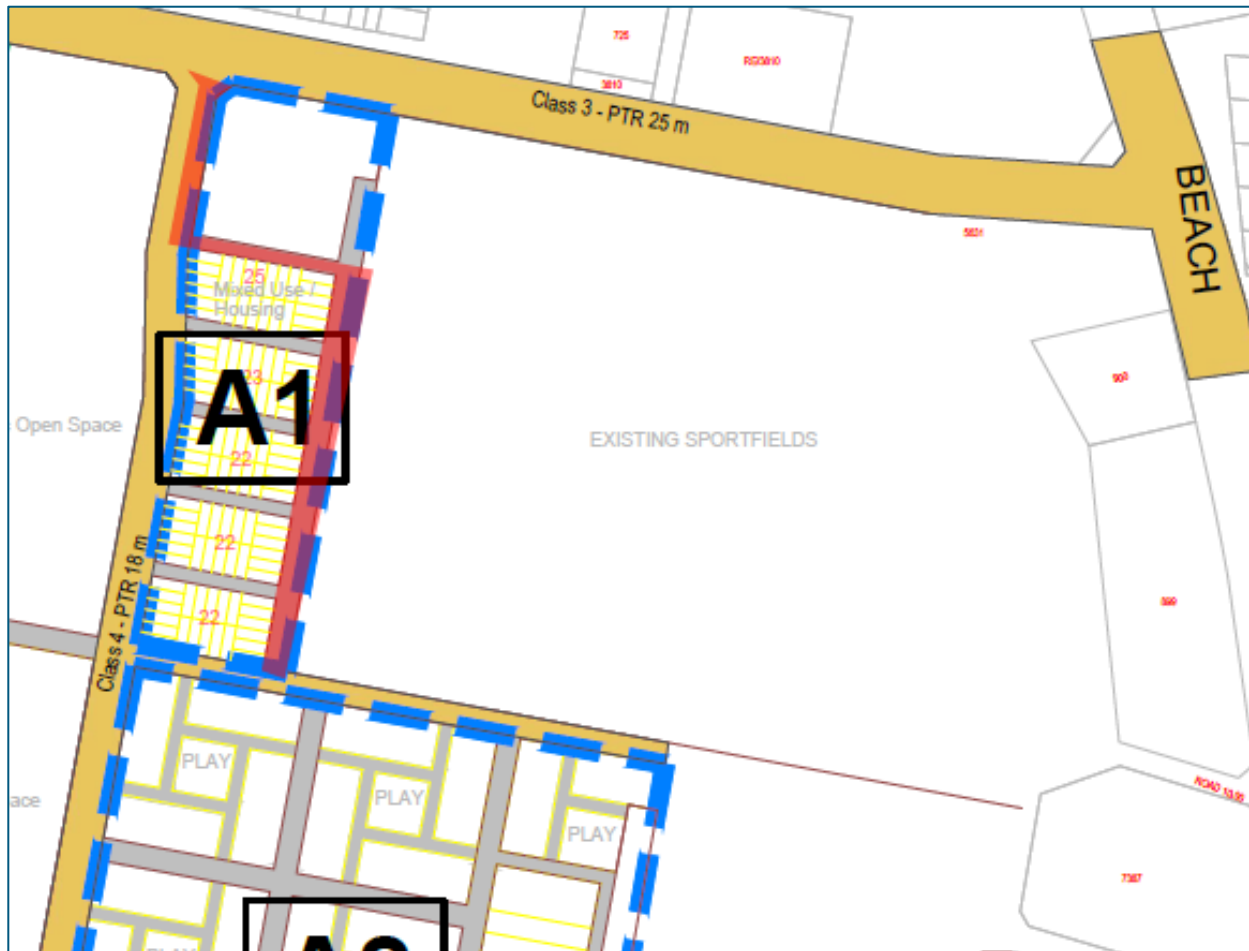

Figure 48: Future housing developments Pacaltsdorp Erf 325 West (Delplan/JSA 2019)

The final detail regarding the route for the access road as well as the requirements for layerworks and surfacing will be concluded during detail design. This will have to be done in collaboration with the GLM so that the access road (and adjacent pipeline routes) can be planned to best effect.

8.7.2 Site security

The new reservoir site, which encompasses the pump station, is to be secured with fencing to GLM specifications, and access and security measures as required by GLM. The fencing is addressed below.

The need for a guardhouse or other such facilities will be addressed in consultation with the GLM end user department in the next design stage.

8.7.3 Fencing

The site as indicated on the Site Layout **Annexure A** will be fenced according to George Municipality latest fencing specifications. The fence approximately 480m long, 2,4m high will consist out of a reinforced high tensile mesh type steel panel & post cast into a concrete foundation and ground beam, security fence, it shall be of the industrial type with all components manufactured by an approved manufacturer.

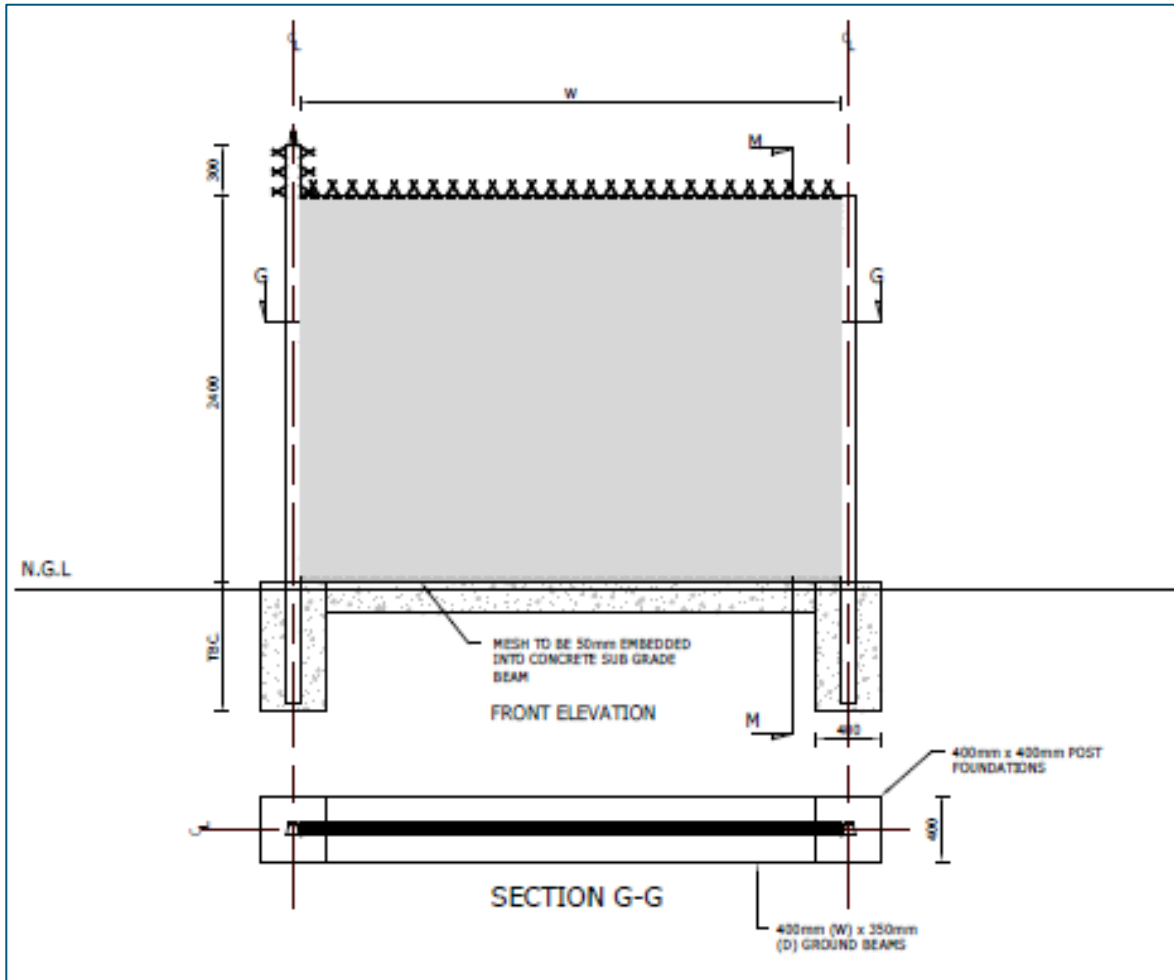

Figure 49: Typical section of perimeter fence (GM fence specification)

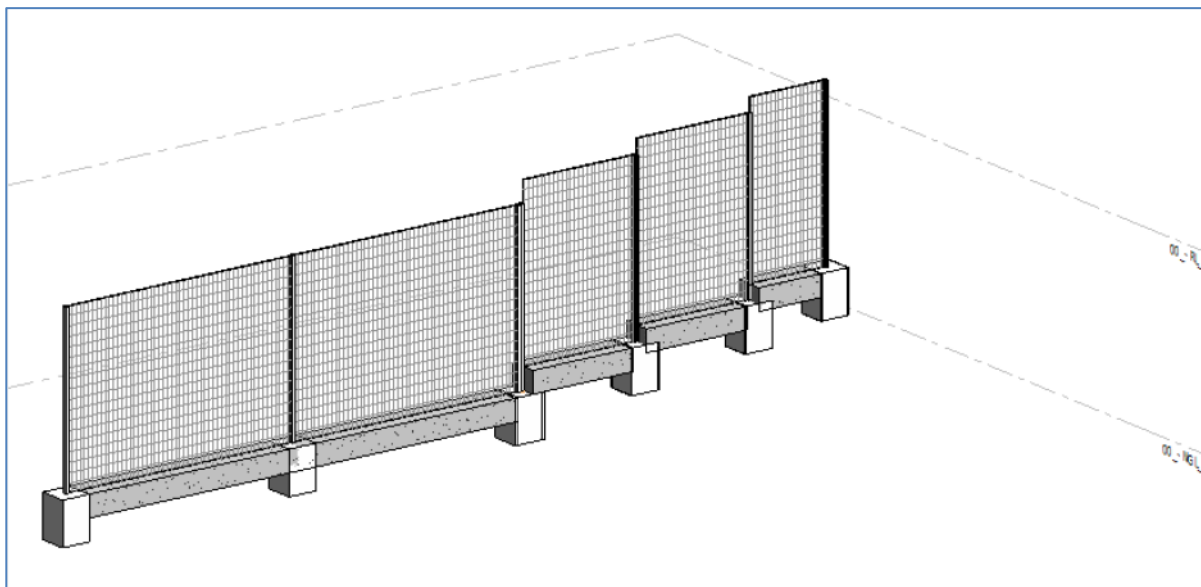

Figure 50: Typical isometric projection of perimeter fence (GM fence specification)

It is proposed that two gates be provided in the fence a vehicle and a pedestrian access gate. It is further proposed that the vehicle access gate be a 6 m sliding gate and the pedestrian access gate a 1 m swing gate. Refer to **Figure 51** and **Figure 52**

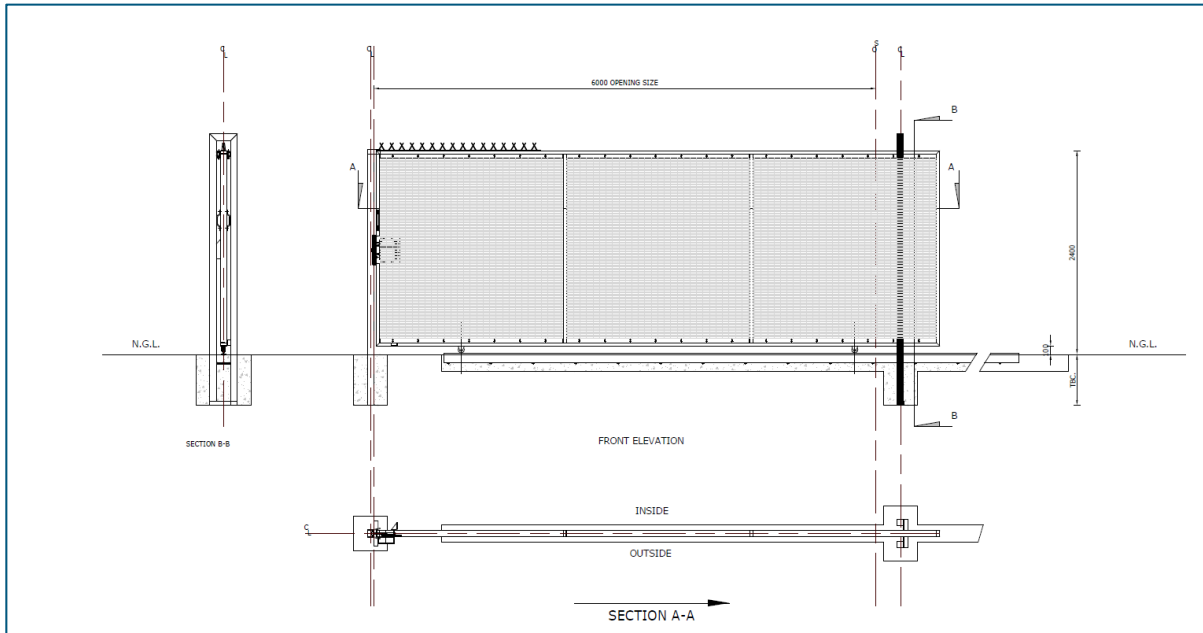

Figure 51: Typical vehicle access gate (GM fence specification)

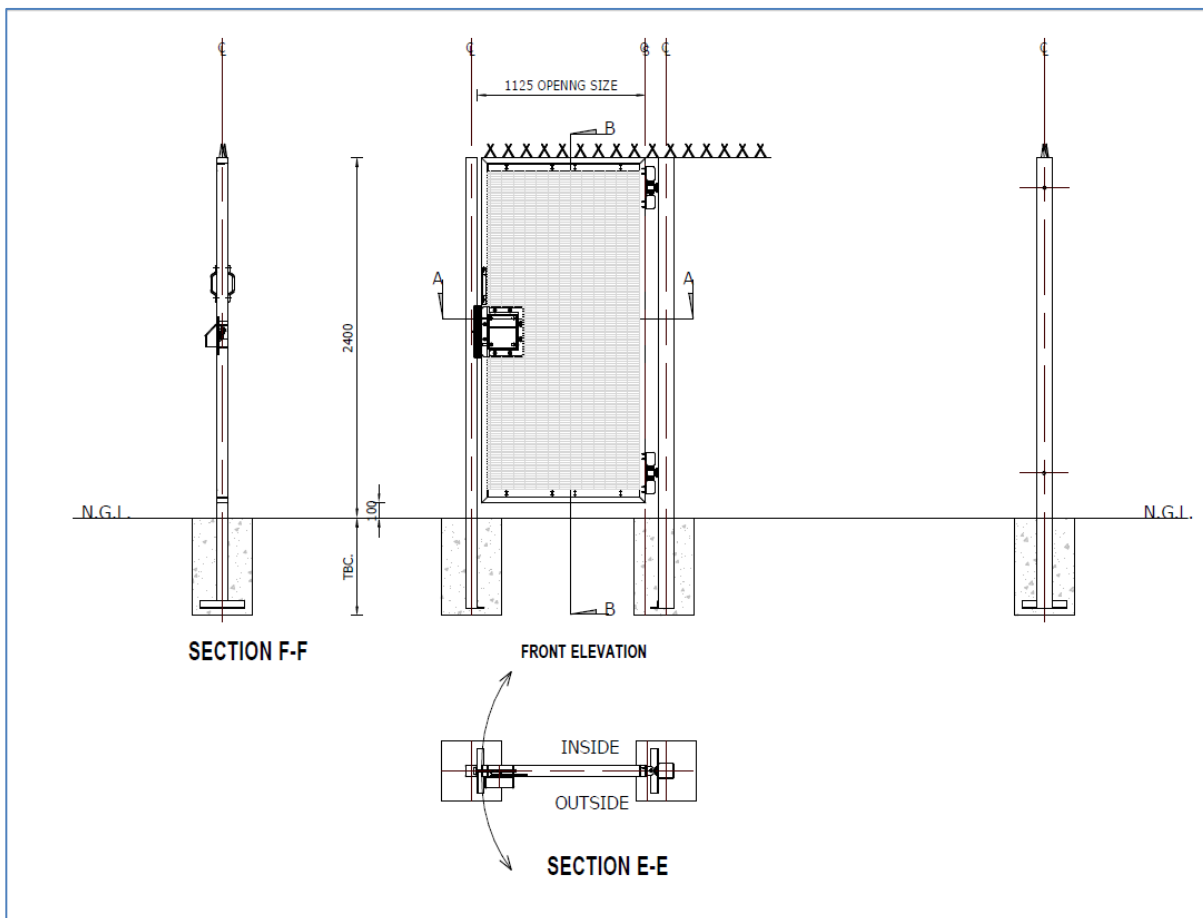

Figure 52: Typical Access gate (GM fence specification)

8.7.4 Stormwater drainage and landscaping

The landscaping and the stormwater drainage of the (reservoir, pumpstation and tower) site must be addressed in a co-ordinated manner. This is in order that the requirements set out in the geotechnical investigation report are fulfilled, i.e.:

“...Good site landscaping and a piped underground stormwater management system is recommended to collect, divert and control the discharge of stormwater from structures, hard surfaces and roads to prevent flooding and ingress into subsoils, which could affect the stability of the soils below structures and roads, causing settlement or other stability problems.”

Given the topography that generally slopes toward the adjoining wetland and watercourse, it is not anticipated that the drainage of stormwater off the site will be problematic. Similarly, it is not anticipated that there will any difficulty in daylighting the subsoil drainage (from both pumpstation and reservoir) or the reservoir overflow and scour outlets.

The site-specific stormwater management requirements will be developed during the detail design stage once positions, elevations and drainage particulars have been finalised.

9 Sub consultancy services and Statutory and Legislative requirements

Royal HaskoningDHV will manage all sub consultants appointed to complete specialist tasks. The following specialist consultants are envisaged to be required during the project life cycle:

9.1 Geotechnical investigation

A geotechnical site investigation was commissioned and subsequently carried out by Outeniqua Geotechnical Services at the proposed site of the 14,5 M^l reservoirs, pumpstation and future water tower. The soil properties, classification and estimated bearing capacity are required to continue with the foundation designs.

The Geotechnical Engineer responsible for the Geotech investigation was also consulted on the proposed foundation design of the reservoir. His recommendations will be incorporated in the detail design.

A summary of these geotechnical aspects, and their impacts, is discussed in **section 8.3.4.2** (Geotechnical aspects).

The geotechnical report is included as Annexure J.

9.2 Topographical surveys

A number of previous topographical surveys, as well as a more recent (VPM, 2019) survey has been conducted of the existing reservoir site, as well as the sports fields and surrounding area. The proposed reservoir site falls within the area surveyed for the Erf 325 West housing development and some use was made of that survey as well (Bailey&LeRoux, 2013/2017).

The abovementioned topographical survey information has been used to compile this preliminary report, and a more detailed engineering survey will be required during the detailed design phase. This must be done to ensure precise co-ordination of the levels between the new reservoirs and the existing reservoir PWR-01 and tower PWT-01, as described above.

The setting out benchmark level for the proposed reservoir will be correlated by precise level survey (1 mm tolerance) of the overflow levels of the existing Pacaltsdorp reservoir and water tower.

A land surveyor was appointed during May 2023 to do the more detail engineering survey to inform the detail design phase and locate existing services along Beach Road and Olympic roads.

9.3 Environmental

The environmental processes have already been initiated by Royal HaskoningDHV. The earlier findings during the feasibility study showed that the new reservoir is situated next to a water course and, although the presence of Black Wattle is noted on this site, it does contain natural vegetation. The development on this site will therefore require a Water Use License. A detailed WULA takes 8-10 months to prepare, inclusive of the necessary studies and authority consultation, followed by a 90-day decision-making period.

An Environmental Specialist was appointed to undertake the applicability checklist, and the Department of Environmental Affairs and Development Planning (DEADP) replied on 21 December 2022 on the Applicability Checklist submitted. DEADP indicated that the following

listed activities are included in the proposed project and will therefore require a Basic Assessment process to be followed in order to apply for Environmental Authorisation:

- The development of infrastructure or structures with a physical footprint of 100 square metres or more.
- Where such development occurs, if no development setback exists, within 32 metres of a watercourse, measured from the edge of a watercourse.
- The development of reservoirs, excluding dams, with a capacity of more than 250 cubic metres in areas containing indigenous vegetation.
- The clearance of an area of 300 square metres or more of indigenous vegetation except where such clearance of indigenous vegetation is required for maintenance purposes undertaken in accordance with a maintenance management plan, within any critically endangered or endangered ecosystem listed in terms of section 52 of the NEMBA or prior to the publication of such a list, within an area that has been identified as critically endangered in the National Spatial Biodiversity Assessment 2004.

An Environmental Practitioners company was appointed in March 2023 to do a Basic Assessment Report (BAR) and specialist studies,

The appointed Environmental Practitioners appointed Environmental Specialists for the following.

- Aquatic site sensitivity verification, wetland delineation, impact assessment and water use licence application (WULA).
- Botanical site sensitivity verification and assessment.
- Biodiversity site sensitivity verification and assessment.
- Faunal for site sensitivity verification and compliance statement.
- Heritage notice of intent to develop (NID).

Depending on the outcome of the pre-application meeting with the department of Environment Affairs and Development Planning (DEADP) a visual impact assessment may be required

An environmental Notice of Intent to develop, was submitted to department of Environment Affairs and Development Planning (DEADP) in May 2023.

9.4 Health and Safety

A Health and Safety agent for the project was appointed by George Municipality to undertake the role of the Client's Construction Health and Safety Agent in terms of Occupational Health and safety, Act 85 of 1993, The Occupational Health and Safety Specification for Construction (OHSS) has been compiled by the appointed Health and Safety agent. The Health and Safety agent will be required to ensure the highest health and safety standards for all work undertaken within the Contract.

The purpose of the OHSS is to incorporate the requirements of the Contract into a contractual Occupational Health and Safety performance specification, as well as to assist towards achieving compliance with the OHS Act in order to reduce incidents and injuries.

The appointed health and safety agent submitted the SHE specifications required for this project on 15 November 2022.

9.5 Town planning

The previous town planning information obtained from Delplan dated January 2022 shows that the selected site is part of a portion of the remainder of Erf 325. The selected site was planned to be



part of the future integrated high density, subsidized and social housing human settlement projects. It was then proposed to subdivide and rezone the site to Utility Zone to accommodate the proposed infrastructure.

The rezoning process has already been approved by Council and a town planner appointed to prepare the rezoning and subdivision application.

The pre-application meeting with George Municipality was held on 27 March 2023 and formal feedback received.

The formal application which goes hand in hand with the Environmental Basic Assessment process is currently being prepared.

10 Programme

A detailed project programme including all phased timeframes is presented in **Annexure E** of this report. The construction timeframe is estimated at 18 months and the total project life cycle is estimated at 27 months including all legal authorisations, planning, detail design, procurement, and the construction phase of the project.

11 Project cost estimate

The estimated cost to implement the proposed project is summarised **Table 21**.

Table 21 Estimated preliminary costs

Item No	DESCRIPTION		Amount (Excl. VAT)
1	Preliminary and General	20% Pro-Rata	R 8 953 822,29
2	Earthworks (Reservoir)		R 4 330 591,67
3	Concrete Works (Reservoir)		R 17 031 883,32
4	Pipework (Reservoir)		R 941 832,29
5	Structural Steel and Other Metalwork		R 182 823,12
6	Pipework (Temporary)		R 893 485,97
7	Pipework (Permanent) including control valves		R 8 329 844,17
8	Drainage and Scour Pipes		R 1 095 698,27
9	Cut-Ins and Tie-Ins (Temporary)		R 197 237,02
10	Cut-Ins and Tie-Ins (Permanent)		R 293 265,24
11	Valve Chambers		R 772 778,07
12	Cable Ducts		R 41 939,88
13	Sundries		R 528 403,55
14	Telemetry		R 250 000,00
15	Pump Station & Ancillary Work		R 5 750 000,00
16	Access Road		R 1 577 718,95
17	Fence		R 2 551 609 ,91
Subtotal A (Schedule of Quantities)			R 53 722 933 ,72
	Contingencies	15%	R 8 058 440,06
Subtotal B (Subtotal A + Contingencies)			R 61 781 373,77
	Escalation - CPA	10%	R 6 178 137,38
Subtotal C (Subtotal B + Escalation) - Total Construction Value			R 67 959 511.15
Professional Fees			
	Mig Technical Report		R 168 725,57
	Feasibility report		R 381 933,19
	Critical operational design requirements		R 90 880,79
	ECSA Stages 1 to 6, Minus discount (10%)		R 44 802 143,65
Subtotal D (Professional Fees)			R 5 443 710,20
Subtotal E (C+D)			R 73 403 221,35
Recoverable Costs			
	Construction Monitoring	18 months @ R100 000/m	R 1 800 000,00

Project related



Item No	DESCRIPTION		Amount (Excl. VAT)	
	Environmental Control Officer	18 months @ R5 000/m	R	90 000,00
	Environmental		R	391 245,00
	H&S		R	200 000,00
	Geotechnical		R	46 200,00
	Surveys		R	88 900,00
	Zoning Application		R	93 925,00
	Disbursements		R	49 792,00
	Subtotal E (Recoverable Costs)		R	2 760 062,00
	Total Project Budget (Excl. Vat)		R	76 163 283,35
	Vat	15%	R	11 424 492,50
	Total Project Budget (Incl. Vat)		R	87 587 775,86

The preliminary estimated total cost to complete the proposed project amounts to R76,16m excluding VAT, this amount includes all professional fees, disbursements, sub-consultant inputs, construction monitoring, construction activities, contractor's preliminary and general items, escalation and contingencies.

12 Conclusion

This Preliminary Design Report provides details of main design assumptions and parameters used in preparation for the detailed design stage for Phase 1A – the construction of PWR-02, the new 14,5 Ml reservoir for the Pacaltsdorp West bulk supply scheme.

13 References

- DoHS. (2019). The Neighbourhood Planning and Design Guide. *Section J Water Supply*.
- GLM. (2016). Civil Engineering Standards & Requirements for Services.
- GLM. (2021). Guidelines for Development Contributions for Water. *Water Supply System (2021)*.
- GLS, J. V., & GLM, A. S. (2022, September 27). Email: GeorgeIMQS - Pacaltsdorp (Wes) reservoir invloei.
- OGS, I. P. (2022, August 29). GEOTECHNICAL REPORT. *Geotechnical Report for the proposed 14,5 ML Reservoirs, Pacaltsdorp, George*.

Annexure A – Site Layout

Annexure B – Schematic

Annexure C – Water Demand Planning Horizon



Annexure D – Void

Annexure E – Programme

Annexure F – Masterplanning PACS WEST - Proposed Infrastructure



Royal
HaskoningDHV

Annexure G – Masterplanning PACS WEST - GLS Site Layout

Annexure H – Demand Patterns

Annexure I – Pump Data

Annexure J – Geotechnical Report

Refer to: Ref No: 2022\ 14.5 ML Reservoirs Pacaltsdorp\George\Report\Geotechnical Report 29.8.2022 Rev0 (can be made available on request, have not been included to this report due the report size)

Annexure K – GLM Guidelines Excerpts

Annexure L – Drawings

Site Layout Plan	:	MD3229-RHD-XX-SL-DR-0003
Reservoir Plan and Sections	:	MD3229-RHD-XX-XX-GN-C-1102
Pipework and Outlet Chamber	:	MD3229-RHD-XX-NR-DR-C-1105
Pipework Details Inlet Chamber	:	MD3229-RHD-XX-NR-DR-C-1106
Pipework Details Overflow Chamber	:	MD3229-RHD-XX-NR-DR-C-1107